



03010101

Luminarias para alumbrado público vial

PHILIPS



CÓDIGO	DESCRIPCIÓN	POT.	FLUJO LUZ	ÓPTICA	PVR	CLAVE LOGT.
--------	-------------	------	-----------	--------	-----	-------------

Mini Iridium Led IP66 IK08

096985070900	BGS451 GRN29T ^A color: 4000°k	27w	2.372 lm	Media	524 €	3	↗
096985072300	BGS451 ECO28T ^A color: 4000°k	27w	2.264 lm	Media	486 €	3	↗
0969910503903818	BGS451 ECO28T ^A color: 4000°k	27w	2.264 lm	Extensiva	526 €	3	↗
096985073000	BGS451 ECO43T ^A color: 4000°k	40w	3.269 lm	Media	524 €	3	↗
096985076100	BGS451 ECO43T ^A color: 4000°k	40w	3.269 lm	Extensiva	524 €	3	↗

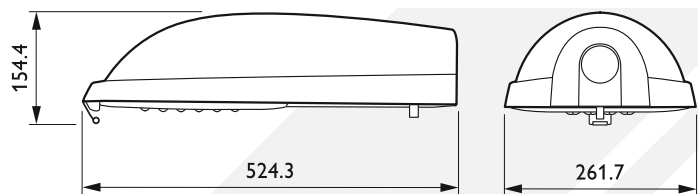
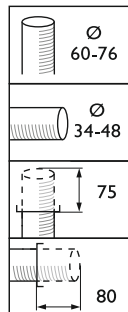
**FACTORES PARA ELEGIR UNA MINI IRIDIUM LED**

Versión según componente óptico: *estos equipos esta sujetos a incrementos en el precio de la luminaria, consultar*.

Versión GreenLine, para una eficacia (lm/w) máxima: 90.000h. de vida.

Versión EconomyLine, para un flujo luminoso maximo: 65.000h. de vida.

EQUIPOS REGULABLES PARA LED

LS-6 ó LS-8: Equipo electrónico doble nivel.

DDF: Equipo electrónico con regulación programable hasta 5 pasos.

RF: Equipo electrónico y sistema de telegestión por radiofrecuencia.

D13: Equipo electrónico para regulación en cabecera.

ÓPTICAS

LPO: Óptica vial.

MSO: Óptica media.

WSO: Óptica ancha.

TEMPERATURA DE COLOR

3000°K.

4000°K.

CÓDIGO	DESCRIPCIÓN	POT.	FLUJO LUZ	Tª COLOR	PVR	CLAVE LOGT.
--------	-------------	------	-----------	----------	-----	-------------

Vital Led IP66 IK10

0969912300016165	BGP670 GRN10"	18w	1.900 lm	4000°k	330 €	3	↗
0969912300016164	BGP670 ECO25/740"	26w	2.500 lm	4000°k	340 €	3	↗
0969912300016163	BGP670 TOP31"	36w	3.100 lm	4000°k	350 €	3	↗

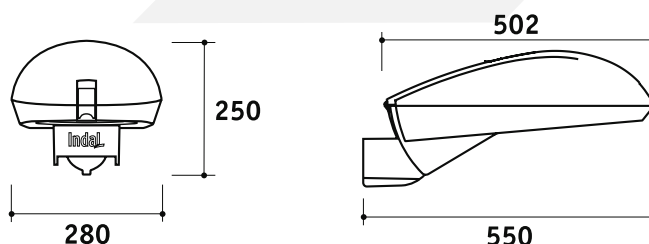

CÓDIGO	DESCRIPCIÓN	POT.	FLUJO LUZ	Tª COLOR	PVR	CLAVE LOGT.
--------	-------------	------	-----------	----------	-----	-------------

Clear Way Led IP66 IK08



CONSULTAR	BGP303 LED29	22w	2.078 lm	4000°k	consultar	3
096991092543792	BGP303 LED35	35w	3.091 lm	4000°k	458 €	3
096906980500	BGP303 LED49	57w	4.382 lm	4000°k	448 €	3
096906981200	BGP303 LED73	83w	6.246 lm	4000°k	512 €	3
0969910925435012	BGP303 LED98	106w	8.366 lm	4000°k	534 €	3
096906983600	BGP303 LED122	131w	10.332 lm	4000°k	577 €	3

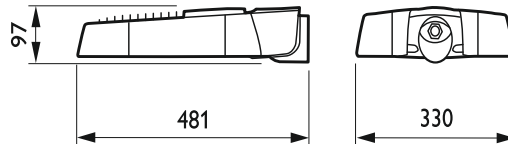
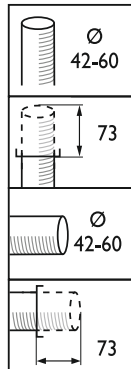

FACTORES PARA ELEGIR UNA CLEAR WAY LED

Equipos Regulables para LED: *estos equipos esta sujetos a incrementos en el precio de la luminaria, consultar*.
LS-6 ó **LS-8:** Equipo electrónico doble nivel.
DDF: Equipo electrónico con regulación programable hasta 5 pasos.
RF: Equipo electrónico y sistema de telegestión por radiofrecuencia.
D13: Equipo electrónico para regulación en cabecera.

Horas de vida: 50.000 h.

TEMPERATURA DE COLOR

3000°K
4000°K

ÓPTICAS

DM: Ledgine multicapa haz medio.

INSTALACIÓN LATERAL O POSTE

Diámetro 42-60 mm.
Diámetro 76 mm.

CÓDIGO	DESCRIPCIÓN	POT.	CASQ.	LÁMPARA	PVR	CLAVE LOGT.
--------	-------------	------	-------	---------	-----	-------------

Vital Descarga IP66 IK08



0969912300012072	SGP670 SON-T 70W	70W	E27	SON-(T) y CDO-TT	199 €	3
0969912300012071	SGP670 SON-T 100W	100W	E40	SON-(T) y CDO-TT	206 €	3
0969912300010153	SGP670 SON-T 150W	150W	E40	SON-(T) y CDO-TT	218 €	3

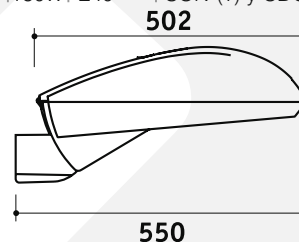
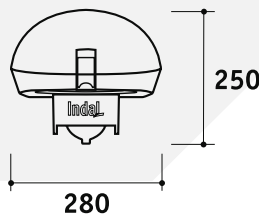

Luminarias para alumbrado público decorativo (LED)

PHILIPS



CÓDIGO	DESCRIPCIÓN	POT.	FLUJO LUZ	Tª COLOR	PVR	CLAVE LOGT.
--------	-------------	------	-----------	----------	-----	-------------

Farol Villa Led IP23



consultar	BDP765 ECOOptica OFR2 Viario	38w	3.300 lm	4000°k	consultar	3
consultar	BDP765 ECOOptica OFR2 Viario	56w	4.900 lm	4000°k	consultar	3
consultar	BDP765 ECOOptica OFR6 Residencial	38w	3.300 lm	4000°k	consultar	3
consultar	BDP765 ECOOptica OFR6 Residencial	56w	4.900 lm	4000°k	consultar	3



CÓDIGO	DESCRIPCIÓN	POT.	FLUJO LUZ	Tª COLOR	PVR	CLAVE LOGT.
--------	-------------	------	-----------	----------	-----	-------------

Quebec IP66 IK10



consultar	BRP775 ECO 24 LEDOptica OFR2 ViarioAcabado blanco brillo RAL 9016	38w	3.300 lm	4000°k	consultar	3	↗
consultar	BRP775 ECO 36 LEDOptica OFR2 ViarioAcabado blanco brillo RAL 9016	56,5w	5.800 lm	4000°k	consultar	3	↗

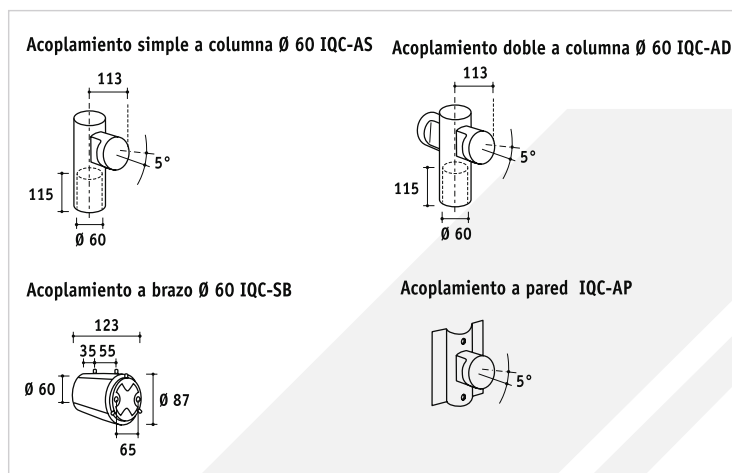
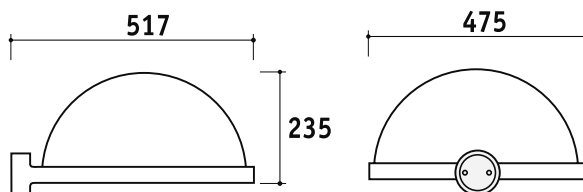

Consultar códigos de acoplamiento en el catálogo del proveedor.

EQUIPOS ESTANDARIZADOS.

DDF1: Equipo electrónico con regulación temporizado.

DD27: Equipo electrónico con regulación temporizado sin hilo de mando.

LS8H: Equipo electrónico y sistema de regulación con Línea de Mando.

03010103

Cajas de conexión, seccionamiento y protección para luminarias de alumbrado público



CÓDIGO	DESCRIPCIÓN	BORNES ENT. N°/SECCION	BORNES SALD. N°C/C	MEDIDAS (MM)	PVR	CLAVE LOGT.
--------	-------------	------------------------	--------------------	--------------	-----	-------------



Cajas de conexión, seccionamiento y protección para luminarias de alumbrado público

0119AC41057	COFRED 1469 M.IP13	4x16	2	150x61x65	13,00 €	1
0119AC41026	COFRED 1468 M.IP13	4x25	2	147x82x65	17,75 €	1
0312010001	CAJA DF20/0 TETRAPOLARIP315. IK 07	4x10	2	139x59x45	13,95 €	1



03010201

Balizas y accesorios (LED)

PHILIPS



CÓDIGO	DESCRIPCIÓN	POT.	FLUJO LUZ	ALTURA mm.	PVR	CLAVE LOGT.
--------	-------------	------	-----------	------------	-----	-------------



Poste Riverside IP44. Clase I. Led

0969163219316	RIVERSIDE POSTE . Acabado antracitaTª de color: 2700°K	7,5w	350 lm	793	82,56 €	3
---------------	--	------	--------	-----	---------	---

CÓDIGO	DESCRIPCIÓN	POT.	CASQ.	ALTURA mm.	PVR	CLAVE LOGT.
--------	-------------	------	-------	------------	-----	-------------

Poste Branche IP44. Clase II. Fluorescencia

0969169358716	BRANCHE. Acabado gris. Lámpara incluida. Tª de color: 2700°K	20w	1 X E27	398	54,50 €	3
0969169359316	BRANCHE BALIZA. Acabado antracita Lámpara incluidaª de color: 2700°K	20w	1 X E27	398	54,50 €	3

+ opciones

CÓDIGO	DESCRIPCIÓN	POT.	FLUJO LUZ	ALTURA mm.	PVR	CLAVE LOGT.
--------	-------------	------	-----------	------------	-----	-------------

Poste Cubase IP54. Led

031855969034M2	CUBASE. Acabado gris.T emperatura de color: 3000°k	12w	640 lm	650	199,00 €	3
----------------	--	-----	--------	-----	----------	---

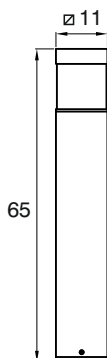



+ opciones

CÓDIGO	DESCRIPCIÓN	POT.	CASQ.	ALTURA mm.	PVR	CLAVE LOGT.
--------	-------------	------	-------	------------	-----	-------------



Poste Nott IP65. IK08. Fluorescencia

031855965505CD | NOTT. Acabado antracita | 23w | 1 X E27 | 500 | 199,00 € | 3 |

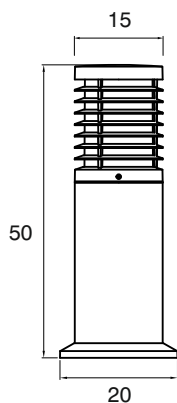

Poste Mandela IP44. Fluorescencia

0318559605Z5M1 | MANDELA. Acabado antracita | 18w | 1 X E27 | 500 | 63,90 € | 3 |

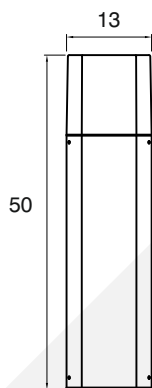

Poste Newton IP65 IK08. Halogenuros metálicos

0318559506Z5M2 | NEWTON. Acabado antracita | 70w | G8,5 | 800 | 283,00 € | 3 |

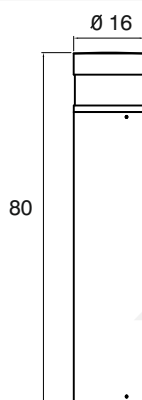

03010202

Luminarias empotrables (en pared y suelos) y accesorios

PHILIPS



CÓDIGO	DESCRIPCIÓN	POT.	FLUJO LUZ	COLOR LED	PVR	CLAVE LOGT.
--------	-------------	------	-----------	-----------	-----	-------------

Empotrable suelo Amazon señalización. Clase II. IP67. IK10. Led



096989739199
096989740799
096989743899

BBC200 LED. 220-240V
BBC200 LED. 220-240V
ACCESORIO DE EMPOTRIMIENTO
ZBC200 TUBE

2w
2w

7 lm
7 lm

Azul
Blanco

79,17 €
79,17 €
18,37 €

3
3
3

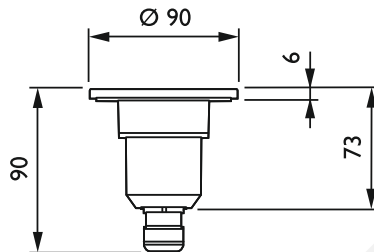

CÓDIGO	DESCRIPCIÓN	POT.	FLUJO LUZ	ACABADO	PVR	CLAVE LOGT.
--------	-------------	------	-----------	---------	-----	-------------

Empotrable suelo Geo IP67. Led



0969172654716

GEO. 230V Dimensiones: 105X105X222mm.

2,5w

120 lm

|Inoxidable|

57,77 €

3



CÓDIGO	DESCRIPCIÓN	POT.	CASQ.	ACABADO	PVR	CLAVE LOGT.
--------	-------------	------	-------	---------	-----	-------------

Empotrable suelo Timber IP67. Casquillo GU10



0969170744716

TIMBER. 230V Dimensiones:
105X105X222mm.

|35w|

|GU10|

|Inoxidable|

33,06 €

3



CÓDIGO	DESCRIPCIÓN	POT.	CASQ.	ACABADO	PVR	CLAVE LOGT.
--------	-------------	------	-------	---------	-----	-------------

Empotrables suelo Axent. Clase I. IP67. IK09. Fluorescencia



0193700003
0193710107

AXENT.
CAJA EMPOTRAR AXENT (accesorio
obligatorio para su colocación)

36w

2G11

|Gris
metalizado|

33,06 €

3

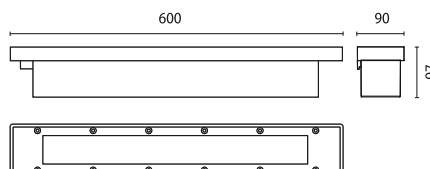



CÓDIGO	DESCRIPCIÓN	POT.	CASQ.	ACABADO	PVR	CLAVE LOGT.
--------	-------------	------	-------	---------	-----	-------------



Empotrable pared Gradus. Clase I. IP66. IK10. Fluorescencia

0193700158	GRADUS	23w	1 X E27	Blanco	48,50 €	3
0193700159	GRADUS	23w	1 X E27	Gris	48,50 €	3
0193700160	GRADUS	23w	1 X E27	metalizado antracita	48,50 €	3

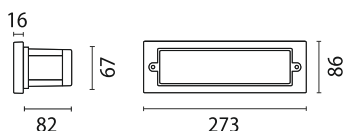

CÓDIGO	DESCRIPCIÓN	POT.	COLOR LED	ACABADO	PVR	CLAVE LOGT.
--------	-------------	------	-----------	---------	-----	-------------



Empotrable de suelo-pared señalización Outdoor Star 60. IP67. IK10. Led

141058006001NX	OUTDOOR STAR LED 60. 350 MA.	1w	Blanco 4000k	Inox.	45,17 €	3
141058006002NX	OUTDOOR STAR LED 60. 350 MA.	1w	Azul		45,17 €	3

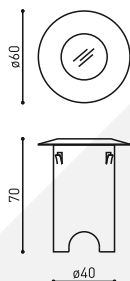

CÓDIGO	DESCRIPCIÓN	POT.	CORRIENTE CONSTANTE	IP	PVR	CLAVE LOGT.
--------	-------------	------	---------------------	----	-----	-------------

Driver

141004860435	DRIVER LED FLOOR + EQUIPO INCLUIDO. Óptica orientable: +-40°	4w	230 V	20	13,38 €	3
--------------	--	----	-------	----	---------	---

CÓDIGO	DESCRIPCIÓN	POT.	CASQ.	ACABADO	PVR	CLAVE LOGT.
--------	-------------	------	-------	---------	-----	-------------

Empotrable de suelo Outdoor Floor IP65. IK10. Halogenuros metálicos



141058300007NX	FLOOR + EQUIPO INCLUIDO. Óptica orientable: +-40°	70w	G12	Inox.	276,36 €	3
----------------	---	-----	-----	-------	----------	---

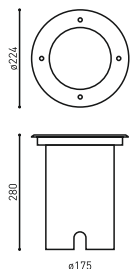

CÓDIGO	DESCRIPCIÓN	POT.	CASQ.	ACABADO	PVR	CLAVE LOGT.
--------	-------------	------	-------	---------	-----	-------------

Empotrable de suelo Recessed Outdoor Floor IP65 IK09. Halógena

141058100000NX	FLOOR 230V	35w	GU10	Inox.	51,43 €	3
----------------	------------	-----	------	-------	---------	---

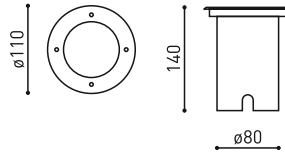
**GRUPO NOVOLUX**

CÓDIGO	DESCRIPCIÓN	POTENCIA	CASQ.	ACABADO	PVR	CLAVE LOGT.
--------	-------------	----------	-------	---------	-----	-------------

Empotrable suelo Bora IP67. Casquillo GU10

1312037AG21X1A30	Bora marco exterior redondo	Led 80W halog. 50W	GU10	Inox.	41,00 €	1
1312037BG21X1A30	Bora marco exterior cuadrado	Led 80W halog. 50W	GU10	Inox.	41,00 €	1

**Empotrable pared Ponenet rectangular IP54. Fluorescencia**

1312251AF1226B03	Ponent rectangular	26W	G24D3	Gris claro	41,00 €	1
------------------	--------------------	-----	-------	------------	---------	---

**+ opciones**

CÓDIGO	DESCRIPCIÓN	POT.	CASQ.	ACABADO	PVR	CLAVE LOGT.
--------	-------------	------	-------	---------	-----	-------------

Empotrable pared Micenas cuadrado IP54. IK04. Fluorescencia

031805943434T2	MICENAS CUADRADO	26w	G24D3	Gris	99,95 €	3
----------------	------------------	-----	-------	------	---------	---

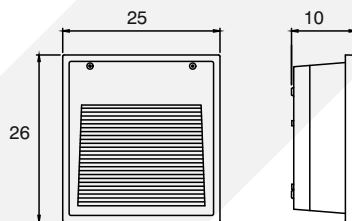
**Empotrable pared Micenas rectangular IP44. IK06. Fluorescencia**

031805917914B8	MICENAS RECTANGULAR	26w	G24D3	Blanco	44,00 €	3
031805917934B8	MICENAS RECTANGULAR	26w	G24D3	Gris	44,00 €	3
0318059179Z5B8	MICENAS RECTANGULAR	26w	G24D3	Gris antracita	44,00 €	3

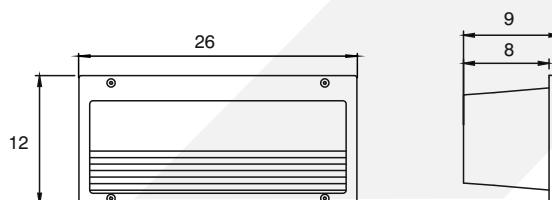



03010203

Apliques, plafones, luminarias de sobremuro y accesorios

PHILIPS



CÓDIGO	DESCRIPCIÓN	POT.	FLUJO LUZ	Tª COLOR	PVR	CLAVE LOGT.
--------	-------------	------	-----------	----------	-----	-------------

**Gondola Led IP65. IK10. Led**

096989249599	BWG201 1XLED. Acabado blanco	24w	800 lm	3000°k	141,00 €	3	↗
096989250199	BWG201 1XLED. Acabado blanco	24w	800 lm	4000°k	141,00 €	3	↗

CÓDIGO	DESCRIPCIÓN	POT.	CASQ.	ACABADO	PVR	CLAVE LOGT.
--------	-------------	------	-------	---------	-----	-------------

**Gondola IP67. IK10. Casquillo E27. Fluorescencia compacta**

096989237299	FWG211	70w	E27	Blanco	35,00 €	3	↗
096989222899	FWG251	2x26w	G24-Q3	Blanco	99,00 €	3	↗

CÓDIGO	DESCRIPCIÓN	POT.	FLUJO LUZ	Tª COLOR	PVR	CLAVE LOGT.
--------	-------------	------	-----------	----------	-----	-------------

**Riverside pared IP 44. Clase I. Led**

0969163209316	RIVERSIDE. Acabado antracita. Dimensiones: 114X128X82mm	7,5w	350 lm	2700°k	57,77 €	3	↗
---------------	--	------	--------	--------	---------	---	---

CÓDIGO	DESCRIPCIÓN	POT.	CASQ.	ACABADO	PVR	CLAVE LOGT.
--------	-------------	------	-------	---------	-----	-------------

**Branche pared E27. IP44. Clase II. Fluorescencia**

0969169348716	BRANCHE. Lámpara incluida. Dimensiones: 285X80X195mm	20w	E27	Gris	36,32 €	3	↗
0969169349316	BRANCHE. Lámpara incluida. Dimensiones: 285X80X195mm	20w	E27	Antracita	36,32 €	3	↗

Nighting Ale pared, emision de luz bidireccional IP44. Clase I. Halógena

0969171024712	NIGHTING ALE. Dimensiones: 160x97x82mm	2x35w	2xGU10	Inox.	28,93 €	3	↗
---------------	---	-------	--------	-------	---------	---	---

Patch pared IP44. Clase I. Fluorescencia

0969171308716	PATCH LANTERN. Lámpara incluida. Dimensiones: 75X356X93mm	27w	E27	Gris	41,24 €	3	↗
0969171309316	PATCH LANTERN. Lámpara incluida. Dimensiones: 75X356X93mm	27w	E27	Antracita	41,24 €	3	↗

GRUPO NOVOLUX

	CÓDIGO	DESCRIPCIÓN	POTENCIA	CASQ.	ACABADO	PVR	CLAVE LOGT.
	Aplique Kira techo y pared IP65. IK05						
	1312169AG05X1A04	Aluminio y policarbonato opal	2x20w (fluorescencia)	E27	Antracita	37,00 €	1
	1312169AG05X1A03	Aluminio y policarbonato opal	2x20w (fluorescencia)	E27	Gris claro	37,00 €	3
	Aplique Pampero techo y pared IP65. IK10						
	1312232AG05X1A01	Aluminio y cristal mate	11w (fluorescencia)	E27	Blanco	38,00 €	3
	1312232AG05X1A03	Aluminio y cristal mate	11w (fluorescencia)	E27	Gris claro	38,00 €	1
	1312051BG05X1A04	Aluminio y policarbonato opal	20w (fluorescencia)	E27	Antracita	37,00 €	1

03010204

Luminarias sobre columnas

PHILIPS

	CÓDIGO	DESCRIPCIÓN	POT.	FLUJO LUZ	Tª COLOR	PVR	CLAVE LOGT.
	Streetsaver. Clase II. IP65. IK10. Led						
	096906525900	BPP007 LED. Acabado antracita	40w	2443 lm	3000ºk	400,00 €	3
	096906526600	BPP007 LED. Acabado antracita	40w	2417 lm	4000ºk	400,00 €	3
							

disano

	CÓDIGO	DESCRIPCIÓN	POT.	FLUJO LUZ	Tª COLOR	PVR	CLAVE LOGT.
	042842560000	GLOBO Diametro 400mm. Acabado plata arenado	24w	2000 lm	3000ºk	372,00 €	3



03010301

Proyectores de alumbrado exterior

PHILIPS



CÓDIGO	DESCRIPCIÓN	POT.	ÓPTICA	ACABADO	PVR	CLAVE LOGT.
--------	-------------	------	--------	---------	-----	-------------

Tempo 1 IP65. IK07. Halogenuro metálico

096989751300

RVP151 MHN-TD/CDM-TD - Lámpara no incluida

70w

Simétrica

Gris

101,00 €

1



096914960800

RVP151 MHN-TD/CDM-TD - Lámpara no incluida

70w

Asimétrica

Gris

101,00 €

1

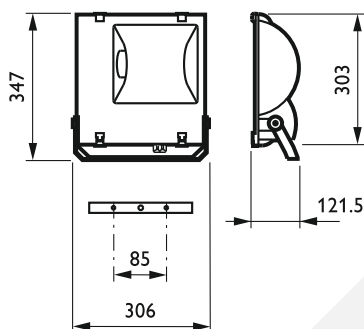
**Tempo 2 IP65. IK07. Halogenuro metálico**

096914961500

RVP251 MHN-TD - Lámpara incluida

150w

Simétrica

Gris

148,00 €

1



096914960800

RVP251 MHN-TD - Lámpara incluida

150w

Asimétrica

Gris

148,00 €

1

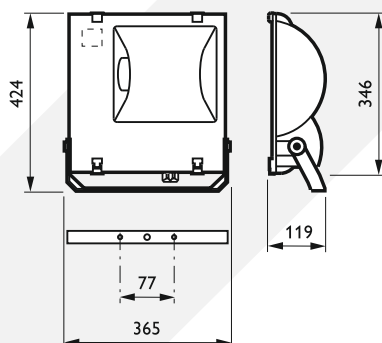
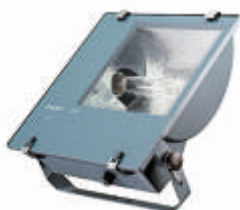
**Tempo 3 IP65. IK07. Halogenuro metálico**

096914971400

RVP351 HPI-T - Lámpara incluida

250w

Simétrica

Gris

174,00 €

1



096914971400

RVP351 HPI-T - Lámpara incluida

250w

Asimétrica

Gris

174,00 €

1



096914973800

RVP351 HPI-T - Lámpara incluida

400w

Simétrica

Gris

182,00 €

1



096914973800

RVP351 HPI-T - Lámpara incluida

400w

Asimétrica

Gris

182,00 €

1

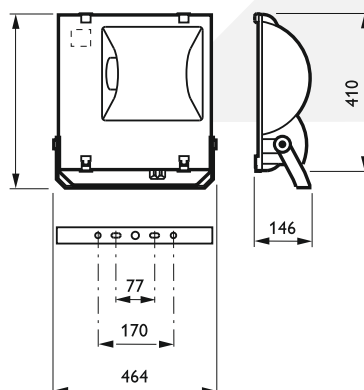



CÓDIGO	DESCRIPCIÓN	POT.	FLUJO LUZ	ÓPTICA	PVR	CLAVE LOGT.
--------	-------------	------	-----------	--------	-----	-------------

Proyector Led IP65. IK08. Led

0193CHT5009	PROYECTOR LED 5000°K	10w	800 lm	Simétrica	55,00 €	1
0193CHT5019	PROYECTOR LED 5000°K	30w	2.400 lm	Simétrica	110,00 €	1
0193CHT5029	PROYECTOR LED 5000°K	50w	4.000 lm	Simétrica	220,00 €	1
0193CHT5049	PROYECTOR LED 5000°K	100w	8.000 lm	Simétrica	450,00 €	3
0193CHT5069	PROYECTOR LED 5000°K	200w	16.000 lm	Simétrica	780,00 €	3



Proyector Jolly Led IP65. IK07. Led

019306084894	JOLLY LED 5000°K	2x40w	5.932 lm	Asimétrica	450,00 €	1
019306085294	JOLLY LED 5000°K	2x50w	7.245 lm	Asimétrica	575,00 €	1



CÓDIGO	DESCRIPCIÓN	POT.	ÓPTICA	ACABADO	PVR	CLAVE LOGT.
--------	-------------	------	--------	---------	-----	-------------

Proyector Jolly 1 IP65. IK07. Halogenuros metálicos

019307023194	JOLLY 1 - Lámpara incluida	70W	Simétrica	Gris	consultar	3
019307023094	JOLLY 1 - Lámpara incluida	150W	Simétrica	urbano	80,00 €	3
019307022994	JOLLY 1 - Lámpara incluida	70W	Asimétrica	RAL9006	95,00 €	3
019307022894	JOLLY 1 - Lámpara incluida	150W	Asimétrica		80,00 €	3



Proyector Jolly 2 IP65. IK07. Halogenuros metálicos

019307020394	JOLLY 2 - Lámpara incluida	250w	Simétrica	Gris	120,00 €	1
019307020594	JOLLY 2 - Lámpara incluida	400w	Simétrica	urbano	135,00 €	1
019307020794	JOLLY 2 - Lámpara incluida	250w	Asimétrica	RAL9006	120,00 €	1
019307020994	JOLLY 2 - Lámpara incluida	400w	Asimétrica		135,00 €	1



CÓDIGO	DESCRIPCIÓN	ACABADO	PVR	CLAVE LOGT.
--------	-------------	---------	-----	-------------

Accesorios

019314235013	Soporte de tubo de acero 500mm. Diametro 22. Brazo pared	Negro	26,50 €	1
--------------	--	-------	---------	---

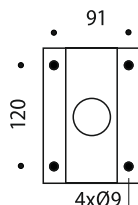

Dimensiones de anclaje



03010302

Proyectores arquitecturales

PHILIPS



CÓDIGO	DESCRIPCIÓN	POT.	FLUJO LUZ	ÓPTICA	PVR	CLAVE LOGT.
--------	-------------	------	-----------	--------	-----	-------------

Vaya Linear IP65. Clase I. Led

096979573499	BCP420 6XLED 3000°K Longitud: 333mm	21w	750 lm	50x50	210,00 €	3	↗
096979574199	BCP420 6XLED 3000°K Longitud: 333mm	21w	750 lm	50x10	210,00 €	3	↗
096979575899	BCP420 6XLed 4000°K Longitud: 333mm	21w	750 lm	50x50	210,00 €	3	↗
096979576599	BCP420 6XLed 4000°K Longitud: 333mm	21w	750 lm	50x10	210,00 €	3	↗
096979567300	BCP420 18XLED3000°K Longitud: 1000mm	42w	1.500 lm	50x50	436,00 €	3	↗
096979568000	BCP420 18XLED3000°K Longitud: 1000mm	42w	1.500 lm	50x10	436,00 €	3	↗
096979569700	BCP420 18XLED4000°K Longitud: 1000mm	42w	1.500 lm	50x50	436,00 €	3	↗
096979570300	BCP420 18XLED4000°K Longitud: 1000mm	42w	1.500 lm	50x10	436,00 €	3	↗
096979591899	BCP420 18XLEDRGB Longitud: 333mm	42w	Comp.	50x50	271,00 €	3	↗
096979592599	BCP420 18XLEDRGB Longitud: 333mm	42w	con	50x10	271,00 €	3	↗
096979591899	BCP420 18XLEDRGB Longitud: 1000mm	42w	contr.	50x50	486,00 €	3	↗
096979580200	BCP420 18XLEDRGB Longitud: 1000mm	42w	DMX/RDM	50x10	486,00 €	3	↗

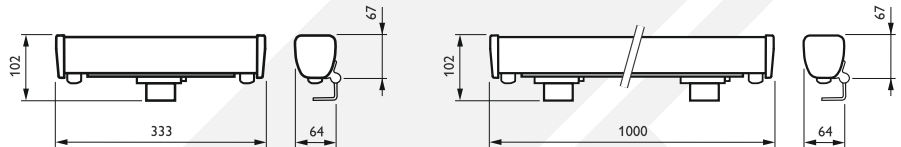

CÓDIGO	DESCRIPCIÓN	COLOR	PVR	CLAVE LOGT.
--------	-------------	-------	-----	-------------

Vaya Touch Control DMX

096937776499	VAYACT LRC2012 VAYA TOUCH	Blanco	210,00 €	3	↗
096937777199	VAYACT LRC2012 VAYA TOUCH	Negro	210,00 €	3	↗

Controlador DMX con funcionalidades básicas. Dispone de una rueda de colores táctil para la selección de cualquier color, permite guardar 6 colores y dispone de 6 programas dinámicos preestablecido. Adicionalmente permite modificar la opción elegida en intensidad y velocidad. Incorpora fuente de alimentación a 24Vdc.

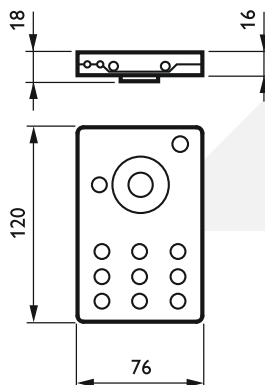

03010303

Proyectores grandes áreas y zonas deportivas

PHILIPS



CÓDIGO	DESCRIPCIÓN	POT.	Tº COLOR	ÓPTICA	PVR	CLAVE LOGT.
--------	-------------	------	----------	--------	-----	-------------

Vista IZM IP66 IK08. Halogenuros metálicos



Consultar	XVG IZM MHN-LA	1000w	4200°k	Dispersiona	1.103,00 €	3	↗
Consultar	XVG IZM MHN-LA	2000w	4200°k	Dispersiona	1.113,00 €	3	↗
Consultar	XVG IZM MHN-SA	2000w	4200°k	Dispersiona	1.534,00 €	3	↗
Consultar	XVG IZM MHN-LA	1000w	4200°k	Media	1.103,00 €	3	↗
Consultar	XVG IZM MHN-LA	2000w	4200°k	Media	1.113,00 €	3	↗
Consultar	XVG IZM MHN-SA	2000w	4200°k	Media	1.534,00 €	3	↗
Consultar	XVG IZM MHN-LA	1000w	4200°k	Concent.	1.103,00 €	3	↗
Consultar	XVG IZM MHN-LA	2000w	4200°k	Concent.	1.113,00 €	3	↗
Consultar	XVG IZM MHN-SA	2000w	4200°k	Concent.	1.534,00 €	3	↗
Consultar	XVG IZM MHN-SA	2000w	4200°k	Superconcent.	1.561,00 €	3	↗

CÓDIGO	DESCRIPCIÓN	PVR	CLAVE LOGT.
--------	-------------	-----	-------------

Accesorios

0969912300012231	IZM-REJILLA NEGRA	152,00 €	3	↗
0969912300012232	IZM-VISERA NEGRA	75,00 €	3	↗
0969912300012052	EQUIPO ZVG IZL/IZM PLACA 1 HM2000W	365,00 €	3	↗
0969912300012053	EQUIPO ZVG IZL/IZM PLACA 3 HM1000W	301,00 €	3	↗
0969912300012054	EQUIPO ZVG IZM PLACA 4 HM2000W	365,00 €	3	↗
0969912300012055	EQUIPO ZVG IZL/IZM COFRE 1 HM2000W	417,00 €	3	↗
0969912300012056	EQUIPO ZVG IZL/IZM COFRE 3 HM1000W	351,00 €	3	↗
0969912300012057	EQUIPO ZVG IZM COFRE 4 HM2000W	463,00 €	3	↗



03010304

Proyectores pequeños para jardín

PHILIPS



CÓDIGO	DESCRIPCIÓN	POT.	CASQ.	DIMENSIONES mm.	PVR	CLAVE LOGT.
--------	-------------	------	-------	-----------------	-----	-------------

Proyector botanic IP44 clase I. Fluorescencia compacta

0969175158716	BOTANIC PARED	2x3w	E27	402x166x98	61,57 €	3	↗
0969175168716	BOTANIC PARED CON SENSOR	2x3w	E27	404x166x98	79,67 €	3	↗
0969175178716	BOTANIC PINCHO JARDIN	2x3w	E27	438x166x120	74,30 €	3	↗



CÓDIGO	DESCRIPCIÓN	POT.	CASQ.	ACABADO	PVR	CLAVE LOGT.
--------	-------------	------	-------	---------	-----	-------------

Proyector Jay IP65. IK08. Clase II

019304023781	JAY 12VTRANSFORMADOR INCLUIDO	50w	GU5,3	Negro RAL9005	105,50 €	3
019301043481	JAY 230VFLUORESCENCIA COMPACTA	12w	E27	Negro RAL9005	62,50 €	3



CÓDIGO	DESCRIPCIÓN	PVR	CLAVE LOGT.
--------	-------------	-----	-------------

Accesorios

019314091981	LIRA de 600mm. De inox, completa con base aluminio. Pintada en negro. INOX.600MM NG.	53,00 €	3
019314092081	LIRA de 300mm. De inox, completa con base aluminio. Pintada en negro. INOX.600MM NG.	47,00 €	3
019314092181	Base de aluminio inyectado, pintado en negro	21,50 €	3
019314092202	Pica de acero galvanizado, para instalación en tierra	16,50 €	3

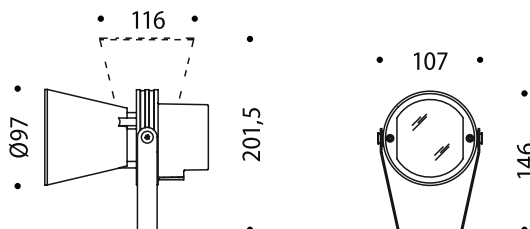

GRUPO | NOVOLUX

CÓDIGO	DESCRIPCIÓN	POTENCIA	CASQ.	INCLUYE	PVR	CLAVE LOGT.
	Proyector Gerónimo IP65. IK08					
	03180596400537	Acabado negro. Fabricado en Poliamida y vidrio transparente	5W. Max. led.	GU10	Pincho tierra	34,00 €

 **opciones**

CÓDIGO	DESCRIPCIÓN	POT.	LÁMPARA	INCLUYE	PVR	CLAVE LOGT.	
	Proyector Helio IP65 IK08						
	03180596400537	PROYECTOR HELIO GU10 NEGRO	50w	Halógena	Pincho tierra	34,95 €	3
	03180596401437	PROYECTOR HELIO GU10 BLANCO	50w	incluida		34,95 €	3
	03180596403437	PROYECTOR HELIO GU10 GRIS	50w			34,95 €	3
CÓDIGO	DESCRIPCIÓN	PVR	CLAVE LOGT.				

Accesorios

03187194873434	LIRA de 83 cm. Acabado Gris	24,80 €	3
03187194872525	LIRA de 83 cm. Acabado Negro	24,80 €	3

PERFORMANCE iN LIGHTING

PERFORMANCE IN LIGHTING ESPAÑA, S.A.

C/ PONT DE CAN CLAVERÍ, nº 58, POL. IND. "LA LLANA"
08191 - RUBÍ (BARCELONA)
TEL. 93 699 55 54 / FAX. 93 699 50 45

marketing@pil-spain.com
www.pil-spain.com















03010305

Proyectores sumergibles (empotrar y superficie) y accesorios

PHILIPS



CÓDIGO	DESCRIPCIÓN	POT.	FLUJO LUZ	ÓPTICA	PVR	CLAVE LOGT.
--------	-------------	------	-----------	--------	-----	-------------

Colorsplash IP68. Led

096970184100	BCP468 18XLED RGB 24V	32w	515 lm	22	1.071,00 €	3	↗
096970185800	BCP468 18XLED RGB 24V	32w	515 lm	12	1.071,00 €	3	↗



Sumergible 5m. Uso agua salada y agua dulce. Necesita fuente de alimentación específica para el producto y controlador compatible DMX.

CÓDIGO	DESCRIPCIÓN	PVR	CLAVE LOGT.
--------	-------------	-----	-------------

Accesorios

096971085499	ZCX400 Fuente de alimentación 60W IP66 Preprogramada PDS-60 24V	300,00 €	3	↗
096971086199	ZCX400 Fuente de alimentación 60W 24V DMX/ ETHER	347,00 €	3	↗

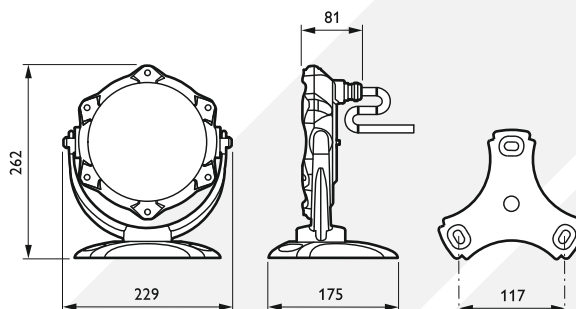

CÓDIGO	DESCRIPCIÓN	POT.	FLUJO LUZ	Tª COLOR	PVR	CLAVE LOGT.
--------	-------------	------	-----------	----------	-----	-------------

Amphilux micro proyector IP68. Led

096989305899	BVD400 1XLED12VGrados de apertura 20°	1,5w	65 lm	6000°k	286,00 €	3	↗
096989306599	BVD400 1XLED12VGrados de apertura 20°	1,5w	60 lm	4000°k	286,00 €	3	↗
096989307299	BVD400 1XLED12VGrados de apertura 20°	1,5w	55 lm	2700°k	286,00 €	3	↗
096989308999	BVD400 1XLED12VGrados de apertura 20°	1,5w	14 lm	Azul	286,00 €	3	↗



Sumergible 10m. Uso agua dulce.

CÓDIGO	DESCRIPCIÓN	PVR	CLAVE LOGT.
--------	-------------	-----	-------------

Accesorios



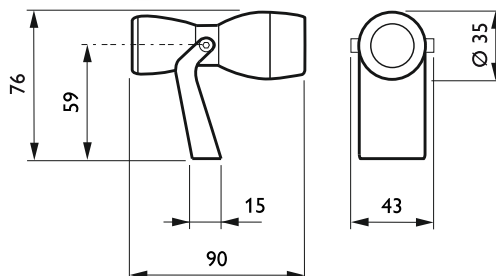

096989721699	Fuente de alimentación. LED POWER DRIVER 60W-12V	75,00 €	3	↗
--------------	--	---------	---	---



CÓDIGO	DESCRIPCIÓN	POT.	FLUJO LUZ	Tª COLOR	PVR	CLAVE LOGT.
--------	-------------	------	-----------	----------	-----	-------------

Amphilux micro empotrable IP68. Led





096989317199	BBD400 1XLED12V Grados de apertura 20°	1,5w	65 lm	6000°k	214,00 €	3	
096989318899	BBD400 1XLED12V Grados de apertura 20°	1,5w	60 lm	4000°k	214,00 €	3	
096989319599	BBD400 1XLED12V Grados de apertura 20°	1,5w	55 lm	2700°k	214,00 €	3	
096989320199	BBD400 1XLED12V Grados de apertura 20°	1,5w	14 lm	Azul	214,00 €	3	

Sumergible 10m. Uso agua dulce.

CÓDIGO	DESCRIPCIÓN	PVR	CLAVE LOGT.
--------	-------------	-----	-------------

Accesorios

096989341699	Accesorio de empotramiento (versión 1 LED) ZBD400 RMB	17,00 €	3	
096989721699	Fuente de alimentación. LED POWER DRIVER 60W-12V	75,00 €	3	

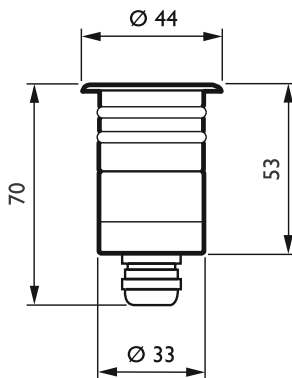

Nota: consultar en catalogo, mas potencias y grados de apertura de modelos Amphilux.



03010401

Luminarias empotradas y accesorios

PHILIPS



CÓDIGO	DESCRIPCIÓN	POT.	FLUJO LUZ	Tª COLOR	PVR	CLAVE LOGT.
--------	-------------	------	-----------	----------	-----	-------------

**Empotrable perfil visto. Led**

096989755199 | CORELINE. RC120B LED Vida útil: 30.000H | 42w | 3700 lm | 4000°k | 198,00 € | 1 |



CÓDIGO	DESCRIPCIÓN	POT.	CASQ.	EQUIPO	PVR	CLAVE LOGT.
--------	-------------	------	-------	--------	-----	-------------

**Empotrable perfil visto. Fluorescencia**

096988801600 | TBS165. Lámparas incluidas. Óptica: reflector aluminio brillo y lamas plana aluminio mate | 4x14w | G5 (T5) | Electrónico HF-E | 77,00 € | 1 |

**Empotrable polivalente. Fluorescencia**

096959008100 | TBS160. Óptica: reflector aluminio brillo y lamas plana aluminio mate | 4x18w | G13 (T8) | Electrónico HF-E | 78,00 € | 1 |

agujero en escayola 577x577mm.

CÓDIGO	DESCRIPCIÓN	PVR	CLAVE LOGT.
--------	-------------	-----	-------------

Accesorios

096929966299 | ANCLAJES PARA COLOCAR EN ESCAYOLA 10 LUM. (40 UDS.) | 19,00 € | 1 |

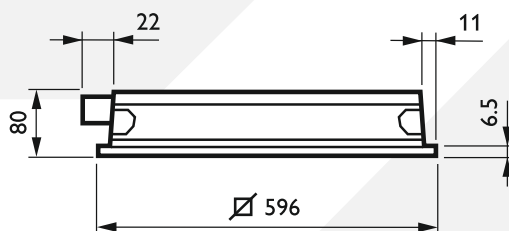

disano

CÓDIGO	DESCRIPCIÓN	POT.	FLUJO LUZ	Tª COLOR	PVR	CLAVE LOGT.
--------	-------------	------	-----------	----------	-----	-------------

**Empotrable perfil visto. Led**

042815353500 | 841 MINICOMFORT LED Difusor lama brillo | 43w | 4800 lm | 4000°k | 240,00 € | 3 |

CÓDIGO	DESCRIPCIÓN	POT.	FLUJO LUZ	Tª COLOR	PVR	CLAVE LOGT.
--------	-------------	------	-----------	----------	-----	-------------



042815020000	840 LED PANEL Difusor Opal	36w	3700 lm	4000°k	240,00 €	3
--------------	----------------------------	-----	---------	--------	----------	---

CÓDIGO	DESCRIPCIÓN	POT.	EQUIPO	ACABADO	PVR	CLAVE LOGT.
--------	-------------	------	--------	---------	-----	-------------

**Empotrable polivalente. Fluorescencia**

042815354300	MINICOMFORT 853 Lámparas incluidas 4000°k	4x14w	Electréc.	Blanco	86,00 €	1
042815354351	MINICOMFORT 853 Lámparas incluidas 4000°k Regulable 1-10v	4x14w	Electréc.	Blanco	170,00 €	3

CÓDIGO	DESCRIPCIÓN	PVR	CLAVE LOGT.
--------	-------------	-----	-------------

Accesorios

042899805900	ACCESORIO DE EMPOTRAMIENTO ESCAYOLA	7,00 €	1
--------------	-------------------------------------	--------	---

CÓDIGO	DESCRIPCIÓN	POT.	EQUIPO	ACABADO	PVR	CLAVE LOGT.
--------	-------------	------	--------	---------	-----	-------------

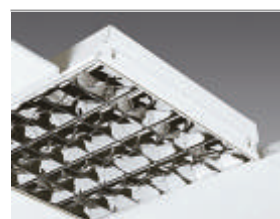
**Empotrable perfil visto. Fluorescencia**

042815042008	COMFORTLIGHT 864 Lámparas incluidas 4000°k	4x18w	Electréc.	Blanco	70,00 €	1
042815042051	COMFORTLIGHT 864 Lámparas incluidas 4000°k Regulable 1-10v	4x18w	Electréc.	Blanco	160,00 €	3

simon

CÓDIGO	DESCRIPCIÓN	POT.	FLUJO LUZ	Tª COLOR	PVR	CLAVE LOGT.
--------	-------------	------	-----------	----------	-----	-------------

**Empotrable polivalente. Led**

032372660030884	MODULAR 726. Difusor Opal. 600X600mm	44w	3.200 lm	4000°k	190,00 €	1
032372095030039	accesorio empotrar en escayola				55,00 €	1
032372060040884	MOD. 720Difusor prismático.600x600mm	34w	4.100 lm	4000°k	350,00 €	3
032372095030039	accesorio empotrar en escayola				55,00 €	1

SYLVANIA

CÓDIGO	DESCRIPCIÓN	POT.	FLUJO LUZ	Tª COLOR	PVR	CLAVE LOGT.
--------	-------------	------	-----------	----------	-----	-------------

**Empotrable perfil visto. Led**

02020047570	STAR PANEL. Difusor Opal. 600X600mm	45w	3.850 lm	3000°k	190,00 €	1
02020047571	STAR PANEL. Difusor Opal. 600X600mm	45w	3.950 lm	4000°k	190,00 €	1



03010402

Luminarias superficie y accesorios

PHILIPS



CÓDIGO	DESCRIPCIÓN	POT.	FLUJO LUZ	Tª COLOR	PVR	CLAVE LOGT.
--------	-------------	------	-----------	----------	-----	-------------

Suspendida y adosable. Led

096989761299	CORELINE. SM120V LED	42w	3700 lm	4000°k	210,00 €	1
--------------	----------------------	-----	---------	--------	----------	---

CÓDIGO	DESCRIPCIÓN	PVR	CLAVE LOGT.
--------	-------------	-----	-------------

ACCESORIOS

096989763699	Accesorio para suspender	consultar	1
--------------	--------------------------	-----------	---

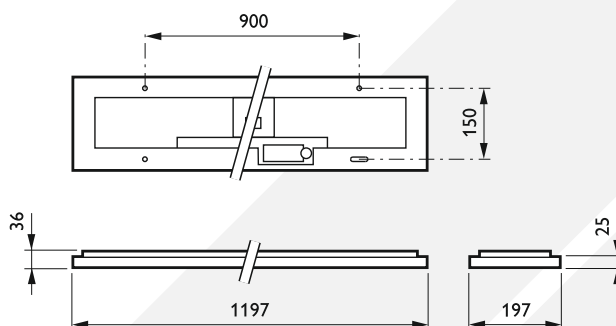

CÓDIGO	DESCRIPCIÓN	POT.	CASQ.	EQUIPO	PVR	CLAVE LOGT.
--------	-------------	------	-------	--------	-----	-------------

Adosable luminaria Centura 2. Fluorescencia

096904312600	CENTURA 2 TCS160	2X36w	G13 (T8)	Electroc.	73,00 €	1
096904314000	CENTURA 2 TCS160	2X58w	G13 (T8)	Electroc.	82,00 €	1

Suspendida y adosable. Fluorescencia

096961231800	TCS260 2X54 Lámpara incluida	2X54w	G5(T5)	Electroc.	108,00 €	3
--------------	------------------------------	-------	--------	-----------	----------	---

CÓDIGO	DESCRIPCIÓN	PVR	CLAVE LOGT.
--------	-------------	-----	-------------

Accesorios

096961110600	ZCS260 SM-3-WH . Kit para suspensión de tres hilos	53,00 €	3
096961403900	ZCS260 CPS-WH. Pieza de unión para realizar líneas continuas	35,00 €	3

03010403

Luminarias de estructuras modulares

PHILIPS



CÓDIGO

DESCRIPCIÓN

PVR

CLAVE
LOGT.

Coreline carril. Led

consultar

Sistema de carriles de alumbrado con tecnología Led. Con un CRI superior al 80% y 50,000 horas de vida

consultar



El uso de tecnología LED, propicia unas vidas útiles más prolongadas, lo que se traduce en menos mantenimiento y piezas de repuesto, un ahorro de energía de hasta el 75% frente a las luminarias tradicionales y, en definitiva, unas soluciones de alumbrado más sostenibles. La calidad y los niveles de luz que brinda la gama CoreLine permiten la sustitución una a una de las luminarias tradicionales similares. Simplemente retire la unidad antigua e instale la innovadora solución LED CoreLine, y apenas habrá que plantear costosos recableados o nuevas configuraciones de techo.



03010501

Luminarias industriales y accesorios

PHILIPS



CÓDIGO	DESCRIPCIÓN	POT.	FLUJO LUZ	Tª COLOR	PVR	CLAVE LOGT.
--------	-------------	------	-----------	----------	-----	-------------

Coreline campana IP65. IK07. Led

096989948700
096989949400

BY120P LED
BY121P LED

110w | 10.000 lm | 4000°k
210w | 20.000 lm | 4000°k

650,00 € | 3 | ⚡
950,00 € | 3 | ⚡

CÓDIGO	DESCRIPCIÓN	PVR	CLAVE LOGT.
--------	-------------	-----	-------------

Accesorios

096989950099
096989951799

LYRA PARA MODELO BY120P
LYRA PARA MODELO BY121P

60,00 € | 3 | ⚡
65,00 € | 3 | ⚡

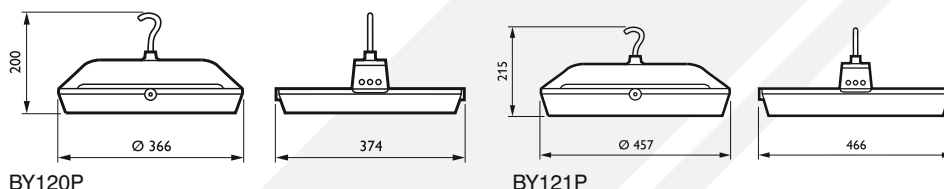

CÓDIGO	DESCRIPCIÓN	POT.	FLUJO LUZ	Tª COLOR	PVR	CLAVE LOGT.
--------	-------------	------	-----------	----------	-----	-------------

Campana Led. IP20. Led

0193CSK3119A | CAMPANA LED

140w | 11.209 lm | 4000°k
4000°k

720,00 € | 3 |



CÓDIGO	DESCRIPCIÓN	POT.	CASQ.	Tª COLOR	PVR	CLAVE LOGT.
--------	-------------	------	-------	----------	-----	-------------

Campana industrial Lucente IP54. IK08. Halogenuros metálicos

042832116300
042832116500

LUCENTE 1101. Lámpara incluida
LUCENTE 1101. Lámpara incluida

250w | E40 | 4500°k
400w

720,00 € | 1 |
170,00 € | 1 |

042881551303

Respuesto de cristal para luminaria Lucente

20,00 € | 1 |

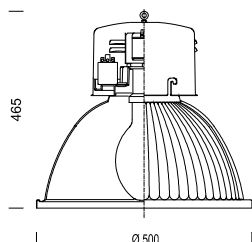

CÓDIGO	DESCRIPCIÓN	POT.	CASQ.	Tª COLOR	PVR	CLAVE LOGT.
--------	-------------	------	-------	----------	-----	-------------

Campana industrial Argon IP65. IK08. Halogenuros metálicos

042832264300	ARGON 1170. Lámpara incluida	250w	E40	4500°k	215,00 €	1
042832264400	ARGON 1170. Lámpara incluida	400w	E40	4500°k	215,00 €	1

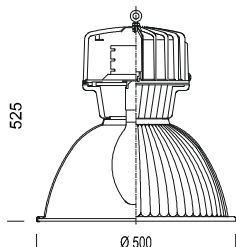

03010502

Pantallas estancas y accesorios**PHILIPS**

CÓDIGO	DESCRIPCIÓN	POT.	FLUJO LUZ	LONGITUD	PVR	CLAVE LOGT.
--------	-------------	------	-----------	----------	-----	-------------

Coreline estanca IP65 IK08. Led

096984046600	WT120C LED.4000°K Policarbonato.50.000h	21w	2200 lm	120mm	105,00 €	1	↗
096984048000	WT120C LED.4000°K Policarbonato.50.000h	40w	4000 lm	120mm	115,00 €	1	↗
096984047300	WT120C LED.4000°K Policarbonato.50.000h	29w	3400 lm	1500mm	195,00 €	1	↗
096984049700	WT120C LED.4000°K Policarbonato.50.000h	49w	6000 lm	1500mm	200,00 €	1	↗



CÓDIGO	DESCRIPCIÓN	POT.	EQUIPO	DIFUSOR	PVR	CLAVE LOGT.
--------	-------------	------	--------	---------	-----	-------------

TCW060 IP65/IK08. Fluorescencia

096981377699	TCW060	1x18w	Electroc.	Policar-	26,00 €	1	↗
096981379099	TCW060	1x36w	HF Tres	bonato	33,00 €	1	↗
096981381399	TCW060	1x58w	encend.		46,00 €	1	↗
096981378399	TCW060	2x18w	diarios		33,00 €	1	↗
096981380699	TCW060	2x36w			43,00 €	1	↗
096981382099	TCW060	2x58w			56,00 €	1	↗



CÓDIGO	DESCRIPCIÓN	PVR	CLAVE LOGT.
--------	-------------	-----	-------------

Accesorios

096988776799	ZCW060 CLIPS ACERO TL-D (10 UNDS)	3,00 €	1	↗
0969992200110438	DIFUSOR PC 2X36W PARA TCW060	24,45 €	1	↗

SYLVANIA

CÓDIGO	DESCRIPCIÓN	POT.	FLUJO LUZ	LONGITUD	PVR	CLAVE LOGT.
--------	-------------	------	-----------	----------	-----	-------------

Sylproof Superia IP65 IK08. Led

02020047684	SYLPROOF SUPERIA4000°K Policarbonato	24w	2.270 lm	120mm	182,40 €	1
02020047680	SYLPROOF SUPERIA4000°K Policarbonato	48w	4.192 lm	120mm	298,90 €	1
02020047685	SYLPROOF SUPERIA4000°K Policarbonato	40w	3.853 lm	1.500mm	241,90 €	1
02020047686	SYLPROOF SUPERIA4000°K Policarbonato	80w	6.880 lm	1.500mm	403,90 €	1



Horas de vida: 50.000 h

disano

CÓDIGO	DESCRIPCIÓN	POT.	EQUIPO	DIFUSOR	PVR	CLAVE LOGT.
--------	-------------	------	--------	---------	-----	-------------

Hydro IP66 IK08. Fluorescencia

042816453100	921 Hydro	1X36w	Electroc.	Policar-bonato	45,00 €	1
042816453400	921 Hydro	2X36w	Electroc.		48,00 €	1
042816453200	921 Hydro	1X58w	Electroc.		50,00 €	1
042816453500	921 Hydro	2X58w	Electroc.		57,00 €	1

CÓDIGO	DESCRIPCIÓN	PVR	CLAVE LOGT.
--------	-------------	-----	-------------

Accesorios

042881280914	SET CON 8 GANCHOS PARA HYDROS 28w/36w	5,30 €	3
--------------	---------------------------------------	--------	---

TRILUX
 NUEVA LUZ.

CÓDIGO	DESCRIPCIÓN	POT.	EQUIPO	DIFUSOR	PVR	CLAVE LOGT.
--------	-------------	------	--------	---------	-----	-------------

Oleveon IP66 IK08. Fluorescencia

07065820304	OLEVEON	1x18w	Electroc.	Acrílico	23,00 €	1
07065820704	OLEVEON	1x36w	tres	Acrílico	29,00 €	1
07065821004	OLEVEON	1x58w	encend.	Acrílico	33,00 €	1
07065821804	OLEVEON	2x18w	diarios	Acrílico	31,00 €	1
07065822204	OLEVEON	2x36w		Acrílico	33,00 €	1
07065822504	OLEVEON	2x58w		Acrílico	40,00 €	1
070610092137	OLEVEON	1x35w		Policarbo.	39,00 €	1
070610050268	OLEVEON	1X49w		Policarbo.	39,00 €	1
07065640304	OLEVEON	2x35w		Policarbo.	58,00 €	1
07065640504	OLEVEON	2X49w		Policarbo.	58,00 €	1
07065640704	OLEVEON	2X54w		Policarbo.	53,00 €	1

CÓDIGO	DESCRIPCIÓN	DIFUSOR	PVR	CLAVE LOGT.
--------	-------------	---------	-----	-------------

Accesorios

07065320100	DIFUSOR OLEVEON PARA 1X18	Acrílico	12,00 €	3
07065320200	DIFUSOR OLEVEON PARA 1X36	Acrílico	15,00 €	3
07065320300	DIFUSOR OLEVEON PARA 1X58	Acrílico	18,00 €	3
07065320400	DIFUSOR OLEVEON PARA 2X18	Acrílico	15,00 €	3
07065320500	DIFUSOR OLEVEON PARA 2X36	Acrílico	19,00 €	3
07065320600	DIFUSOR OLEVEON PARA 2X58	Acrílico	26,00 €	3
07065838100	DIFUSOR OLEVEON PARA 1X18	Policarbo.	10,00 €	1
07065838200	DIFUSOR OLEVEON PARA 1X36	Policarbo.	10,00 €	1
07065838300	DIFUSOR OLEVEON PARA 1X58	Policarbo.	14,00 €	1
07065838400	DIFUSOR OLEVEON PARA 2X18	Policarbo.	12,00 €	1
07065838500	DIFUSOR OLEVEON PARA 2X36	Policarbo.	14,00 €	1
07065838600	DIFUSOR OLEVEON PARA 2X58	Policarbo.	18,00 €	1
07065851100	Cierre basculante en poliamida para luminaria Oleveon		0,40 €	3
07065827400	Cierre basculante en inoxidable para luminaria Oleveon		1,00 €	1

03010503

Regletas industriales y accesorios

PHILIPS



CÓDIGO	DESCRIPCIÓN	POT.	FLUJO LUZ	LONGITUD	PVR	CLAVE LOGT.
--------	-------------	------	-----------	----------	-----	-------------

Petura Mini Led IP20. Led

096989702599	BN130C LED 3000°K 30.000H	6w	350 lm	359 mm	45,00 €	1	
096989703299	BN130C LED 3000°K 30.000H	10w	683 lm	584 mm	56,00 €	1	

CÓDIGO	DESCRIPCIÓN	POT.	CASQ.	Tª COLOR	PVR	CLAVE LOGT.
--------	-------------	------	-------	----------	-----	-------------

Regleta IP20. Fluorescencia

096904531199	TMS022 HF	1x36w	G13 (T8)	Electroc.	32,00 €	1	
096904533599	TMS022 HF	1x58w	G13 (T8)	Electroc.	34,00 €	1	
096904532899	TMS022 HF	2x36w	G13 (T8)	Electroc.	34,00 €	1	
096904534299	TMS022 HF	2x58w	G13 (T8)	Electroc.	36,00 €	1	

CÓDIGO	DESCRIPCIÓN	PVR	CLAVE LOGT.
--------	-------------	-----	-------------

Accesorios

096920796499	Reflector simetrico GMS022 1/2 36R, para 1 ó 2 lámparas de 36w	16,00 €	1
096920736099	Reflector simetrico GMA022 1/2 58R, para 1 ó 2 lámparas de 58w	18,00 €	1



UN DISEÑO PRUBADO
CON LA TECNOLOGÍA
LED MÁS MODERNA

Oleveon LED

Eficacia energética: un ahorro de más del 50 % gracias al uso de la tecnología LED energéticamente eficiente.

Bajos gastos de mantenimiento: uso de materiales de alta calidad y de módulos LED de larga vida útil.

Solución de saneamiento óptima: puntos de fijación idénticos gracias a la estructura idéntica con respecto a la variante convencional de la familia de productos probada.



CÓDIGO	DESCRIPCIÓN	POT.	CASQ.	EQUIPO	PVR	CLAVE LOGT.
Regleta Ridos 40 IP20. Fluorescencia						
07065796304	RIDOS 40 T5	1x28 /54w	G5 (T5)	Electroc.	33,00 €	1
07065796904	RIDOS 40 T5	1x35 /49/ 80w	G5 (T5)	Electroc.	42,00 €	1



03010504

Apliques industriales, plafones industriales y accesorios



CÓDIGO	DESCRIPCIÓN	POT.	CASQ.	PVR	CLAVE LOGT.
Portalámparas/aplique					
009560152	APLIQUE CASQUILLO	100w	E27	11,35 €	1

CÓDIGO	DESCRIPCIÓN	POT.	CASQ.	DIFUSOR	PVR	CLAVE LOGT.
Hublots plásticos IP44						
009560414	HUBLOT BEBILUX	60w	E27	175x126 x105	8,55 €	1
009560419	HUBLOT BEBILUX	100w	E27	192x147 x111	19,05 €	1

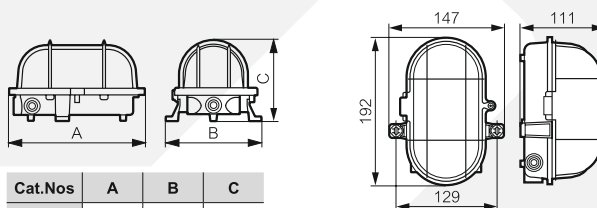

Cat.Nos	A	B	C
604 92	178	126	108
604 05	178	126	108
604 15	169	126	106
604 14	175	126	105

CÓDIGO	DESCRIPCIÓN	POT.	CASQ.	PVR	CLAVE LOGT.
Hublots plásticos redondo IP44					
009560459	HUBLOT REDONDO	100w	E27	26,95 €	1

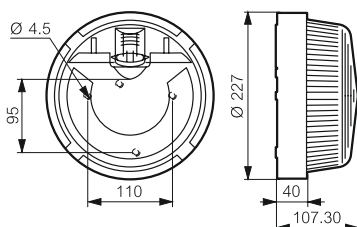

03010601

Downlights (empotrados, superficie) y accesorios

PHILIPS



CÓDIGO	DESCRIPCIÓN	POT.	FLUJO LUZ	Tª COLOR	PVR	CLAVE LOGT.
--------	-------------	------	-----------	----------	-----	-------------



CoreLine Proset orientable IP44. Led

096989862699	RS121B LED Vida útil: 30.000h. Acabado blanco	13w	640 lm	3000°k	42,00 €	3	↗
096989866499	RS121B LED Vida útil: 30.000h. Acabado blanco	13w	640 lm	4000°k	42,00 €	3	↗

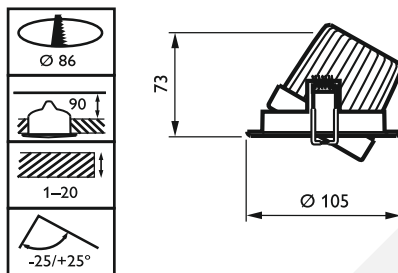

CÓDIGO	DESCRIPCIÓN	POT.	FLUJO LUZ	Tª COLOR	PVR	CLAVE LOGT.
--------	-------------	------	-----------	----------	-----	-------------



CoreLine COMPACT. IP20. Led

096929489699	DN125B LED Vida útil: 30.000h. Acabado blanco	24w	2000 lm	3000°k	92,00 €	3	↗
096929490299	DN125B LED Vida útil: 30.000h. Acabado blanco	24w	2000 lm	4000°k	92,00 €	3	↗

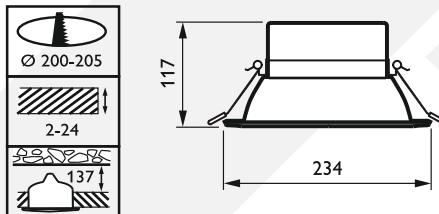

CÓDIGO	DESCRIPCIÓN	POT.	FLUJO LUZ	Tª COLOR	PVR	CLAVE LOGT.
--------	-------------	------	-----------	----------	-----	-------------



LuxSpace Accent 2. Led

096984971100	RS552B LED Vida útil: 50.000h. Óptica MB: 25°, Negro	53w	3900 lm	3000°k	350,00 €	3	↗
096984972800	RS552B LED Vida útil: 50.000h. Óptica MB: 25°, Blanco	53w	3900 lm	3000°k	350,00 €	3	↗
096984974200	RS552B LED Vida útil: 50.000h. Óptica MB: 25°, Negro	49w	4900 lm	3000°k	350,00 €	3	↗
096984974200	RS552B LED Vida útil: 50.000h. Óptica MB: 25°, Blanco	49w	4900 lm	3000°k	350,00 €	3	↗

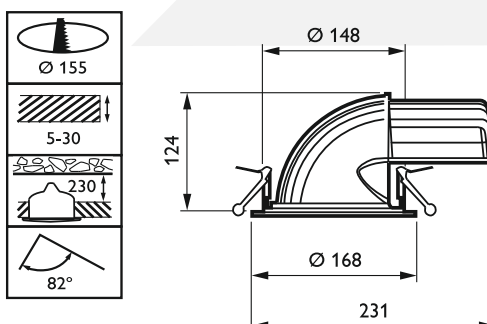



Nueva gama residential lighting



Una luz para cada estancia

Philips residencial lighting combina innovación y diseño ofreciendo las últimas soluciones en tecnología LED.

En cada una de ellas podrá encontrar el producto que mejor se adapte a sus necesidades y a las de su cliente.

Productos imprescindibles para su negocio por su alta calidad al precio más competitivo.

innovation  you



Decorativo



Jardín



Baño



Oficina en casa

PHILIPS

disano

CÓDIGO	DESCRIPCIÓN	POT.	FLUJO LUZ	Tª COLOR	PVR	CLAVE LOGT.
--------	-------------	------	-----------	----------	-----	-------------

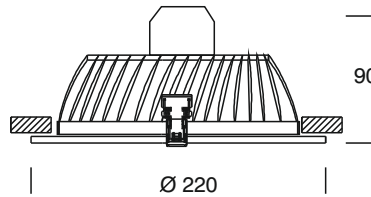
**Lex IP44. Led**04282217341000
04282217341500LEX LED Acabado blanco
LEX LED Acabado blanco20w
20w2.024 lm
2.024 lm3000°k
4000°k72,00 €
72,00 €3
3

diámetro de corte 205 mm

CÓDIGO	DESCRIPCIÓN	POT.	FLUJO LUZ	Tª COLOR	PVR	CLAVE LOGT.
--------	-------------	------	-----------	----------	-----	-------------

**Low Glare IP20. Led**

04282206147200

LOW GLARE 2 Acabado aluminio satinado

11w

680 lm

2700°k

45,00 €

2

diámetro de corte 70-80 mm

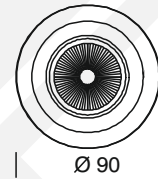
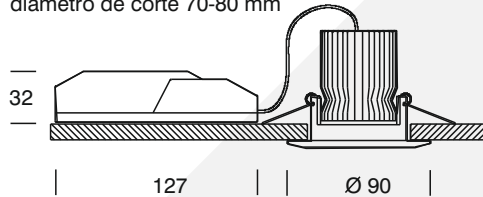
EFICIENCIA EN
LA RELACIÓN
CALIDAD-PRECIO**Ambietta LED****Eficacia energética:** un ahorro energético de hasta un 57 %, gracias al uso de la tecnología LED eficiente.**Posibilidades de uso universales:** 3 paquetes lumínicos en 2 temperaturas de color cada uno.**Amortización rápida:** una solución LED completa a un precio atractivo.



simon

CÓDIGO	DESCRIPCIÓN	POT.	FLUJO LUZ	Tª COLOR	PVR	CLAVE LOGT.
Downlight 725.22. IP20. Led						
032372522030983	Acabado blanco. Vida útil: 30.000h.	24w	2100 lm	3000°k	110,00 €	3
032372522030984	Acabado blanco. Vida útil: 30.000h.	24w	2300 lm	4000°k	110,00 €	1
032372522030986	Acabado blanco. Vida útil: 30.000h.	24w	2400 lm	6500°k	110,00 €	1
032372522033983	Acabado aluminio. Vida útil: 30.000h.	24w	2100 lm	3000°k	110,00 €	3
032372522033984	Acabado aluminio. Vida útil: 30.000h.	24w	2300 lm	4000°k	110,00 €	1
032372522033986	Acabado aluminio. Vida útil: 30.000h.	24w	2400 lm	6500°k	110,00 €	1

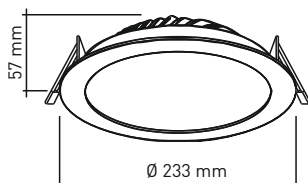

diámetro de empotramiento 210 mm

Downlight 725.23 IP20 30.000H

032372523030983	Acabado blanco. Vida útil: 30.000h.	14w	1200 lm	3000°k	95,00 €	3
032372523030984	Acabado blanco. Vida útil: 30.000h.	14w	1300 lm	4000°k	95,00 €	1
032372523030986	Acabado blanco. Vida útil: 30.000h.	14w	1400 lm	6500°k	95,00 €	1
032372523033983	Acabado aluminio. Vida útil: 30.000h.	14w	1200 lm	3000°k	95,00 €	3
032372523033984	Acabado aluminio. Vida útil: 30.000h.	14w	1300 lm	4000°k	95,00 €	1
032372523033986	Acabado aluminio. Vida útil: 30.000h.	14w	1400 lm	6500°k	95,00 €	1

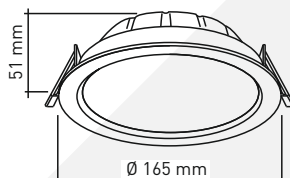

diámetro de empotramiento 150 mm

Downlight 705.23. IP20. Led

032370523030483	Acab. blanco. Óptica 40° Vida útil: 30.000h	15,5w	1000 lm	3100°k	37,00 €	1
032370523030484	Acab. blanco. Óptica 40° Vida útil: 30.000h	15,5w	1080 lm	3900°k	37,00 €	1
032370523033483	Acab. aluminio. Óptica 40° Vida útil: 30.000h	15,5w	1000 lm	3100°k	37,00 €	1
032370523033484	Acab. aluminio. Óptica 40° Vida útil: 30.000h	15,5w	1080 lm	3900°k	37,00 €	1



diámetro de empotramiento 75 mm

Downlight 705.24. IP20. Led

032370524030483	Acab. blanco. Óptica 40° Vida útil: 30.000h	15,5w	1000 lm	3100°k	37,00 €	1
032370524030484	Acab. blanco. Óptica 40° Vida útil: 30.000h	15,5w	1080 lm	3900°k	37,00 €	1
032370524033483	Acab. aluminio. Óptica 40° Vida útil: 30.000h	15,5w	1000 lm	3100°k	37,00 €	1
032370524033484	Acab. aluminio. Óptica 40° Vida útil: 30.000h	15,5w	1080 lm	3900°k	37,00 €	1



diámetro de empotramiento 82 mm

Downlight 706. IP20. Led

032370620030383	Acab. blanco. Óptica 30° Vida útil: 30.000h	12w	440 lm	3100°k	35,00 €	3
032370620033383	Acab. blanco. Óptica 30° Vida útil: 30.000h	12w	460 lm	3900°k	35,00 €	3
032370620030384	Acab. aluminio. Óptica 30° Vida útil: 30.000h	12w	440 lm	3100°k	35,00 €	3
032370620033384	Acab. aluminio. Óptica 30° Vida útil: 30.000h	12w	460 lm	3900°k	35,00 €	3



diámetro de empotramiento 72 mm



Haz un cambio pásate al **LED**

Tiendas · Oficinas · Hoteles
Restaurantes · Hospitales · Hogares

Consulta nuestra gama de producto



3 AÑOS
DE GARANTÍA

1-10V IP44

www.simonled.com

simon

ARKOS LIGHT®

CÓDIGO	DESCRIPCIÓN	POT.	FLUJO LUZ	Tª COLOR	PVR	CLAVE LOGT.
--------	-------------	------	-----------	----------	-----	-------------

Lex Eco 2 IP20. Led

1410A0700103W	LEX ECO2 Acabado blanco	24,5w	2250 lm	3000°K	109,89 €	3
1410A0700104W	LEX ECO2 Acabado blanco	24,5w	2350 lm	4000°K	109,89 €	3

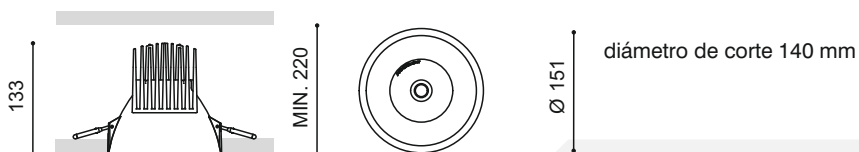

diámetro de corte 140 mm

Mix 2 IP43. IK07. Led

1410A1870212W	MIX 2 Acabado blanco	20w	2000 lm	4000°K	104,77 €	2
1410A1870212Z	MIX 2 Acabado aluminio	20w	2000 lm	4000°K	104,77 €	3



diámetro de corte 205 mm

Mix Mini 2 IP43. IK07. Led

1410A1880212W	MIX MINI-2 Acabado blanco	9w	900 lm	4000°K	71,55 €	3
1410A1880212Z	MIX MINI-2 Acabado aluminio	9w	900 lm	4000°K	71,55 €	3



diámetro de corte 122 mm

Drop 2 IP43. IK07. Led

1410A1930212W	DROP-2 Acabado blanco mate	20w	2000 lm	4000°K	125,22 €	3
---------------	----------------------------	-----	---------	--------	----------	---

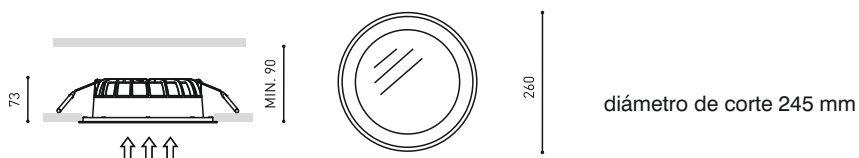

diámetro de corte 245 mm



CÓDIGO	DESCRIPCIÓN	POT.	FLUJO LUZ	Tª COLOR	PVR	CLAVE LOGT.
--------	-------------	------	-----------	----------	-----	-------------

**Bath IP65. Led**

1410A0900106W	BATH CIRCULAR Blanco mate Óptica 40°	8w	625 lm	3000°K	52,00 €	3
1410A1570111W	BATH CUADRADO Blanco mate Óptica 40°	8w	625 lm	3000°K	52,00 €	3

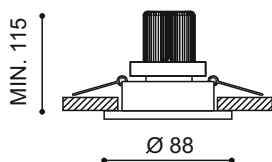

diámetro de corte 70 mm

CÓDIGO	DESCRIPCIÓN	POT.	Tª COLOR	ACABADO	PVR	CLAVE LOGT.
--------	-------------	------	----------	---------	-----	-------------

**Fox IP54. IK10. Fluorescencia**

141042210040W	FOX Lámpara incluida. Fabricado en policarbonato	2x26w	4000°k	Blanco	46,54 €	2
---------------	--	-------	--------	--------	---------	---

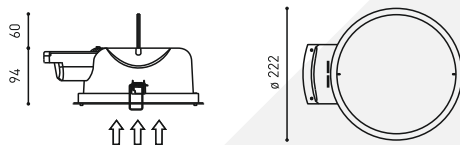

diámetro de corte 205 mm

**Max IP20/54. Fluorescencia**

141040990040B	MAX. Equipo Electrónico. Lámpara incluida. Cristal mate	2x26w	4000°k	Blanco	55,80 €	2
141040990040Z	MAX. Equipo Electrónico. Lámpara incluida. Cristal mate	2x26w	4000°k	Aluminio	56,62 €	3
141040990040NS	MAX. Equipo Electrónico. Lámpara incluida. Cristal mate	2x26w	4000°k	Níquel satinado	61,45 €	2

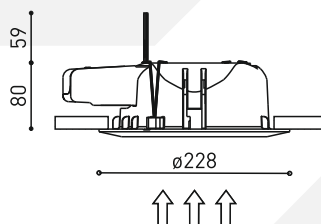

diámetro de corte 205 mm

**Kiss IP20. Fluorescencia**

14104599R040B	KISS. Equipo Electrónico. Lámpara incluida. Cristal mate	2x26w	4000°k	Blanco	31,25 €	1
14104599R040Z	KISS. Equipo Electrónico. Lámpara incluida. Cristal mate	2x26w	4000°k	Aluminio	32,25 €	1

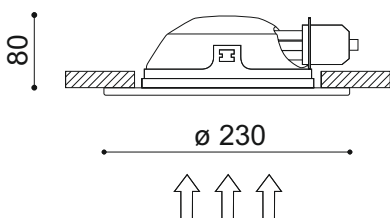

diámetro de corte 205 mm

CÓDIGO	DESCRIPCIÓN	POT.	Tª COLOR	ACABADO	PVR	CLAVE LOGT.
--------	-------------	------	----------	---------	-----	-------------

**Pro TR1 IP20. Fluorescencia**

141040410040W	PRO TR. Equipo Electrónico. Lámpara incluida. Cristal mate	2X26w	4000°K	Blanco	74,73 €	1
141040410040Z	PRO TR1. Equipo Electrónico. Lámpara incluida. Cristal mate	2X26w	4000°K	Aluminio	74,73 €	1

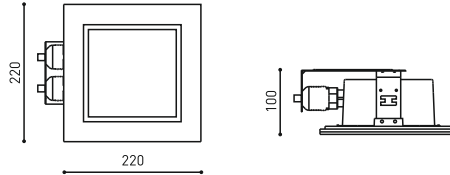

corte cuadrado 205 X 205mm

**TR2 IP20. Fluorescencia**

141041410040Z	PRO TR2. Equipo Electrónico. Lámpara incluida. Cristal mate	2X26w	4000°K	Aluminio	71,54 €	1
---------------	---	-------	--------	----------	---------	---

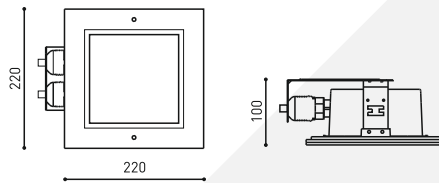

corte cuadrado 205 X 205mm

CÓDIGO	DESCRIPCIÓN	POT.	CASQ.	ACABADO	PVR	CLAVE LOGT.
--------	-------------	------	-------	---------	-----	-------------

**Basic fix. Halógenas 12V**

141000370101B	BASIC FIX. Fijo	50w	GU5,3	Blanco	3,67 €	1
---------------	-----------------	-----	-------	--------	--------	---

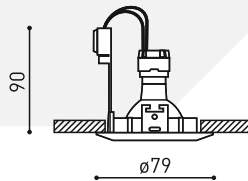

diámetro de corte 62 mm

**Basic Tilt. Halógenas 12V**

141000380101B	BASIC TILT. Orientable	50w	GU5,3	Blanco	5,29 €	1
141000380101N	BASIC TILT. Orientable	50w	GU5,3	Negro	5,29 €	3
141000380101C	BASIC TILT. Orientable	50w	GU5,3	Cromo	7,48 €	3
141000380101Z	BASIC TILT. Orientable	50w	GU5,3	Aluminio	6,25 €	1
141000380101NS	BASIC TILT. Orientable	50w	GU5,3	Níquel St.	7,90 €	3

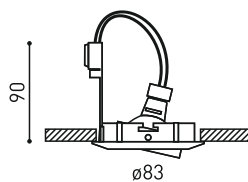

diámetro de corte 75 mm



CÓDIGO	DESCRIPCIÓN	POT.	CASQ.	ACABADO	PVR	CLAVE LOGT.
--------	-------------	------	-------	---------	-----	-------------



Square Tilt. Halógenas 12V

141003040000B	SQUARE TILT. Orientable	50w	GU5,3	Blanco	6,59 €	3
141003040000Z	SQUARE TILT. Orientable	50w	GU5,3	Aluminio	6,84 €	3
141003040000NS	SQUARE TILT. Orientable	50w	GU5,3	Níquel St.	9,71 €	3

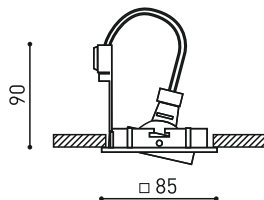

diámetro de corte 75 mm



Basic Mechanized. Halógenas 12V

141000290000P	BASIC MECHANIZED. Orientable	50w	GU5,3	Plata mat.	18,02 €	2
---------------	------------------------------	-----	-------	------------	---------	---

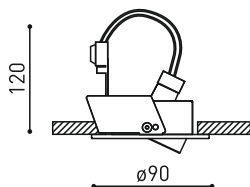

diámetro de corte 82 mm



Square Mechanized. Halógenas 12V

141003130000P	SQUARE MECHANIZED. Orientable	50w	GU5,3	Plata mat.	18,02 €	2
---------------	-------------------------------	-----	-------	------------	---------	---

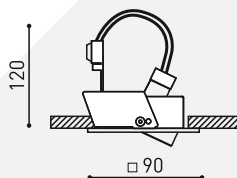

diámetro de corte 82 mm



Bath IP65. Halógenas 12V

141003500000B	BATH CIRCULAR	50w	GU5,3	Blanco	19,36 €	3
141003500000C	BATH CIRCULAR	50w	GU5,3	Cromo	22,87 €	3
141003500000Q	BATH CIRCULAR	50w	GU5,3	Cromo mt.	22,87 €	3
141003510000B	BATH CUADRADO	50w	GU5,3	Blanco	20,89 €	3
141003510000C	BATH CUADRADO	50w	GU5,3	Cromo	24,23 €	3
141003510000Q	BATH CUADRADO	50w	GU5,3	Cromo mt.	24,23 €	3

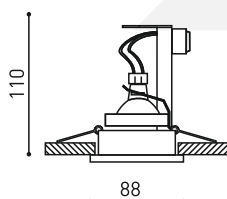

diámetro de corte 70 mm

CÓDIGO	DESCRIPCIÓN	POT.	CASQ.	ACABADO	PVR	CLAVE LOGT.
Ecos. Halógenas 12V						
2088001030	ECOS CUADRADO. Orientable	50w	GU5,3	Blanco	5,20 €	1
2088001032	ECOS CUADRADO. Orientable	50w	GU5,3	Gris tex.	5,20 €	1
2088001035	ECOS CUADRADO. Orientable	50w	GU5,3	Cromo mt.	7,33 €	2
2088001037	ECOS CUADRADO. Orientable	50w	GU5,3	Níquel St.	7,33 €	1

diámetro de corte 75 mm



CÓDIGO	DESCRIPCIÓN	POT.	Tª COLOR	ACABADO	PVR	CLAVE LOGT.
Ducto PL IP20. Fluorescencia						
0184495012684BSC	DUCTO PL. Equipo Electrónico. Lámpara incluida. Cristal transparente serigrafiado	2X26w	4000°K	Blanco	59,59 €	2

diámetro de corte 195 mm



CÓDIGO	DESCRIPCIÓN	POT.	CASQ.	ACABADO	PVR	CLAVE LOGT.
Empotrable circular. Halógena 12V						
018428701	ARO ZAMAC. Fijo	50w	Gu5.3	Blanco	3,09 €	2
018428601	ARO ZAMAC. Orientable	50w	Gu5.3	Blanco	4,70 €	2
018428602	ARO ZAMAC. Orientable	50w	Gu5.3	Negro	6,20 €	3
018428652	ARO ZAMAC. Orientable	50w	Gu5.3	Cromo mt.	6,20 €	2
018428657	ARO ZAMAC. Orientable	50w	Gu5.3	Níquel sat.	5,71 €	2

Empotrable cuadrado. Halógena 12V

018422700	ARO ALUMINIO. Orientable	50w	Gu5.3	Alumino natural	13,92 €	1
-----------	--------------------------	-----	-------	-----------------	---------	---





03010602

Proyectores de interior (carril y base) y accesorios

PHILIPS



CÓDIGO	DESCRIPCIÓN	POT.	FLUJO LUZ	Tª COLOR	PVR	CLAVE LOGT.
Tecostyle 2. Carril trifásico IP20. Led						
096985327500	ST340Optica: 25° de apertura. Vida útil: 50.000h.Acabado negro	25w	1900 lm	3000°k	215,00 €	3
096985328200	ST340Optica: 25° de apertura. Vida útil: 50.000h.Acabado negro	25w	1900 lm	4000°k	215,00 €	3
096985329900	ST340Optica: 36° de apertura. Vida útil: 50.000h.Acabado negro	25w	1900 lm	3000°k	215,00 €	3
096985330500	ST340Optica: 36° de apertura. Vida útil: 50.000h.Acabado negro	25w	1900 lm	4000°k	215,00 €	3
096985331200	ST340Optica: 25° de apertura. Vida útil: 50.000h.Acabado negro	25w	1900 lm	3000°k	215,00 €	3
096985332900	ST340Optica: 25° de apertura. Vida útil: 50.000h.Acabado blanco	25w	1900 lm	4000°k	215,00 €	3
096985333600	ST340Optica: 25° de apertura. Vida útil: 50.000h.Acabado negro	25w	1900 lm	3000°k	215,00 €	3
09698534300	ST340Optica: 25° de apertura. Vida útil: 50.000h.Acabado negro	25w	1900 lm	4000°k	215,00 €	3
096985335000	ST340Optica: 25° de apertura. Vida útil: 50.000h.Acabado negro	35w	2800 lm	3000°k	250,00 €	3
096985336700	ST340Optica: 25° de apertura. Vida útil: 50.000h.Acabado negro	35w	2800 lm	4000°k	250,00 €	3
096985337400	ST340Optica: 36° de apertura. Vida útil: 50.000h.Acabado negro	35w	2800 lm	3000°k	250,00 €	3
096985338100	ST340Optica: 36° de apertura. Vida útil: 50.000h.Acabado negro	35w	2800 lm	4000°k	250,00 €	3
096985339800	ST340Optica: 36° de apertura. Vida útil: 50.000h.Acabado blanco	35w	2800 lm	3000°k	250,00 €	3
096985340400	ST340Optica: 36° de apertura. Vida útil: 50.000h.Acabado blanco	35w	2800 lm	4000°k	250,00 €	3
09698534100	ST340Optica: 39° de apertura. Vida útil: 50.000h.Acabado negro	35w	2800 lm	3000°k	250,00 €	3
096985342800	ST340Optica: 39° de apertura. Vida útil: 50.000h.Acabado negro	35w	2800 lm	4000°k	250,00 €	3









03010603

Luminarias decorativas de techo

PHILIPS



	CÓDIGO	DESCRIPCIÓN	POT.	FLUJO LUZ	Tª COLOR	PVR	CLAVE LOGT.	
	Syma adosar IP20. Led 0969321583116	SYMA. Dimensiones: 47x240x240 mm	6x2,5w	6X120 lm	2700°k	123,14 €	3	
	Styla adosar IP20. Led 0969321573116	STYLA. Dimensiones: 36X230X230 mm	9x2,5w	9X120 lm	2700°k	164,46 €	3	
	Rectangle adosar IP20. Fluorescencia 0969302911716	RECTANGLE. Lámparas incluidas. 3xPL-LD Dimensiones: 70x550x550 mm	3x36w	3X2900 lm	2700°k	156,20 €	3	
	Being adosar IP20. Fluorescencia 0969326104816	BEING. Lámpara incluida. 1xTL5 Circular. Dimensiones: 50x350x350 mm	40w	3300 lm	2700°k	148,68 €	3	
	Spa adosar IP44. Fluorescencia 0969320053116	SPA. Lámpara incluida. 1xE27. Dimensiones: 120x260x260 mm	20w	1250 lm	2700°k	32,98 €	3	
	Amace suspender IP20. Fluorescencia 0969402333116	AMAZE. Acabado blanco. Lámpara incluida. 1xTL5 Circular. Dimensiones 1400x423x432 mm	60w	5000 lm	2700°k	180,99 €	3	
	0969402334816	AMAZE. Acabado aluminio. Lámpara incluida. 1xTL5 Circular. Dimensiones 1400x423x432 mm	60w	5000 lm	2700°k	180,99 €	3	



+ opciones

CÓDIGO	DESCRIPCIÓN	POT.	CASQ.	ACABADO	PVR	CLAVE LOGT.
--------	-------------	------	-------	---------	-----	-------------



Luxomat adosar IP20. Con detector de movimiento alta frecuencia

295194440

LUXOMAT HF-L1 Alcance, valor crepuscular y temporización mediante potenciómetro

60w

E27

Blanco, vidrio satinado mate

74,75 €

1

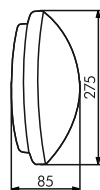
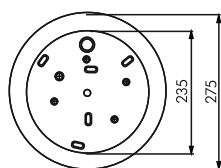

montaje en techo (alt.2,5m)

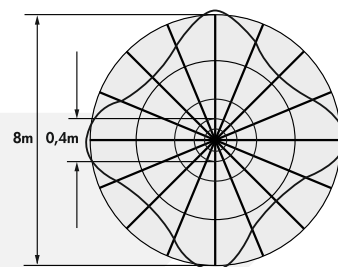
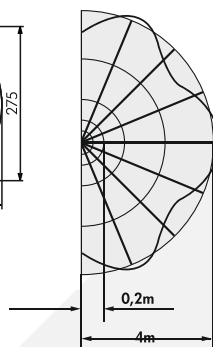

03010604

Luminarias decorativas de pared

PHILIPS



	CÓDIGO	DESCRIPCIÓN	POT.	FLUJO LUZ	Tª COLOR	PVR	CLAVE LOGT.	
	Pytha. Emision de luz bidereccional IP20. Led							
	0969332593116	PYTHA. Acabado blanco. Dimensiones: 146x50x115 mm	2x2,5w	2X120 lm	2700°k	90,08 €	3	↗
	0969332594816	PYTHA. Acabado aluminio. Dimensiones: 146x50x115 mm	2x2,5w	2X120 lm	2700°k	90,08 €	3	↗
	Pnovum. Emision de luz bidireccional IP20. Led							
	0969360523116	NOVUM. Acabado Blanco. Dimensiones: 155x153x107 mm	4,8w	350 lm	2700°k	66,03 €	3	↗
	Hotstone IP44. Led							
	0969340491116	HOTSTONE. Acabado cromo. Dimensiones: 67x146x147 mm	2x2,5w	350 lm	2700°k	65,29 €	3	↗
	0969340501116	HOTSTONE. Acabado cromo. Dimensiones: 59x346x144 mm	4x4,5w	2X350 lm	2700°k	119,83 €	3	↗
	Fit IP44. Led							
	0969340581116	FIT. Acabado cromo. Dimensiones: 63x333x64 mm	2x2,5w	350 lm	2700°k	49,55 €	3	↗
	0969340591116	FIT. Acabado cromo. Dimensiones: 63x483x67 mm	3x2,5w	520 lm	2700°k	66,07 €	3	↗
	Peace. Emisión de luz bidireccional IP20. Fluorescencia							
	0969301853116	PEACE. Acabado blanco. Lámpara incluida. Casquillo 2G7. Dimensiones: 60X286X98 mm	11w	900 lm	2700°k	71,89 €	3	↗
	0969304223116	PEACE. Acabado blanco. Lámpara incluida. Casquillo 2G7. Dimensiones: 60X510X98 mm	36w	2900 lm	2700°k	90,83 €	3	↗
	Vitalise IP44. Fluorescencia							
	0969340931116	VITALISE. Acabado Cromo. Lámpara incluidsa. Casquillo G5. Dimensiones: 60x388x77 mm	8w	750 lm	2700°k	45,45 €	3	↗
	0969340941116	VITALISE. Acabado Cromo. Lámpara incluidsa. Casquillo G5. Dimensiones: 60x616x77 mm	13w	1000 lm	2700°k	82,56 €	3	↗



03010605

Luminarias decorativas de suelo y sobremesa

PHILIPS



CÓDIGO	DESCRIPCIÓN	POT.	FLUJO LUZ	Tª COLOR	PVR	CLAVE LOGT.
--------	-------------	------	-----------	----------	-----	-------------

**Fold IP20. Led**

0969667123016	FOLD REGULABLE. Acabado negro. Dimensiones: 375x222x753 mm	2x7,5w	2X350 lm	2700°k	304,96 €	3	↗
0969667124816	FOLD REGULABLE. Acabado aluminio. Dimensiones: 375x222x753 mm	2x7,5w	2X350 lm	2700°k	304,96 €	3	↗

**Mindset IP 20**

0969669093016	MINDSET. Acabado negro. Dimensiones: 516x165x598 mm	7,5w	350 lm	2700°k	128,10 €	3	↗
0969669098716	MINDSET. Acabado aluminio. Dimensiones: 516x165x598 mm	7,5w	350 lm	2700°k	128,10 €	3	↗

03010606

Carriles electrificados y accesorios

PHILIPS



CÓDIGO	DESCRIPCIÓN	LONG.	ACABADO	PVR	CLAVE LOGT.
--------	-------------	-------	---------	-----	-------------

RCS750. Carril de superficie tres encendidos

096938110700	Carril de superficie tres encendidos	1 m	Blanco	39,00 €	3	↗
096938106000	Carril de superficie tres encendidos	1 m	Aluminio	39,00 €	3	↗
096938111400	Carril de superficie tres encendidos	2 m	Blanco	73,00 €	3	↗
096938107700	Carril de superficie tres encendidos	2 m	Aluminio	73,00 €	3	↗
096938112100	Carril de superficie tres encendidos	3 m	Blanco	98,00 €	3	↗
096938108400	Carril de superficie tres encendidos	3 m	Aluminio	98,00 €	3	↗

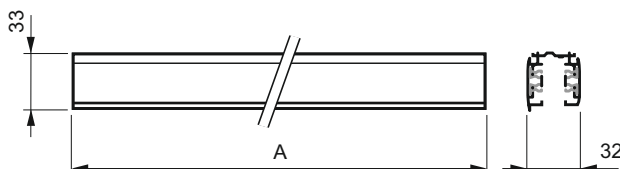

CÓDIGO	DESCRIPCIÓN	LONG.	ACABADO	PVR	CLAVE LOGT.
--------	-------------	-------	---------	-----	-------------

Accesorios

096938118399	Zcs750 icp conector línea		Blanco	1,00 €	3	↗
096938116999	Zcs750 epsr alimentación extremo derecho 250v/16a		Blanco	15,00 €	3	↗
096938114599	Zcs750 epsl alimentación extremo izquierdo 250v/16a		Blanco	15,00 €	3	↗
096938122099	Zcs750 cps alimentación central 250v/16a		Blanco	31,00 €	3	↗
096938126899	Zcs750 ccpi conector interno 90°		Blanco	41,00 €	3	↗
096938128299	Zcs750 ccpe conector externo 90°		Blanco	41,00 €	3	↗
096938136799	Zcs750 acp conector ajust. 60°/300°		Blanco	49,00 €	3	↗
096938120699	Zcs750 cpf conector flexible		Blanco	66,00 €	3	↗
096938130599	Zcs750 tcpr conector en "t" derecha		Blanco	60,00 €	3	↗
096938132999	Zcs750 tcpl conector en "t" izquierda		Blanco	60,00 €	3	↗
096938134399	Zcs750 cpx conector en cruz		Blanco	77,00 €	3	↗
096938124499	Zcs750 ep tapa final		Blanco	2,00 €	3	↗
096952739199	Zcs750 adp adaptador enchufe		Blanco	46,00 €	3	↗
096952906799	Zcs750 adh gancho de suspensión mecánica al carril 3c		Blanco	4,00 €	3	↗
096914983799	Zcs700 mbw80 pletina de fijación a pared l80		Aluminio	42,00 €	3	↗
096937881799	Zcs700 mbw6 pletina de fijación pared a l6		Aluminio	8,00 €	3	↗
096932527999	Zcs700 spc abrazadera para suspensión mediante cable flexible		Aluminio	5,00 €	3	↗
096932530999	Zcs700 spcl abrazadera long 3c suspensión con cable flexible		Aluminio	12,00 €	3	↗
096914988299	Zcs700 sms cable suspensión longitud 1,5m. Incluye tensores			11,00 €	3	↗
096914987599	Zcs700 smc tapa embellecedora cable suspensión + abrazadera del cable		Blanco	6,00 €	3	↗
096914986899	Zcs700 scp placa de fijación por tornillos para montaje del carril directo a techo		Blanco	5,00 €	3	↗
096914985199	Zcs700 scp placa de fijación por tornillos para montaje del carril directo a techo		Aluminio	5,00 €	3	↗
096981374599	Zrs750 3c ad3p adaptador salida 220v wh		Blanco	16,00 €	3	↗

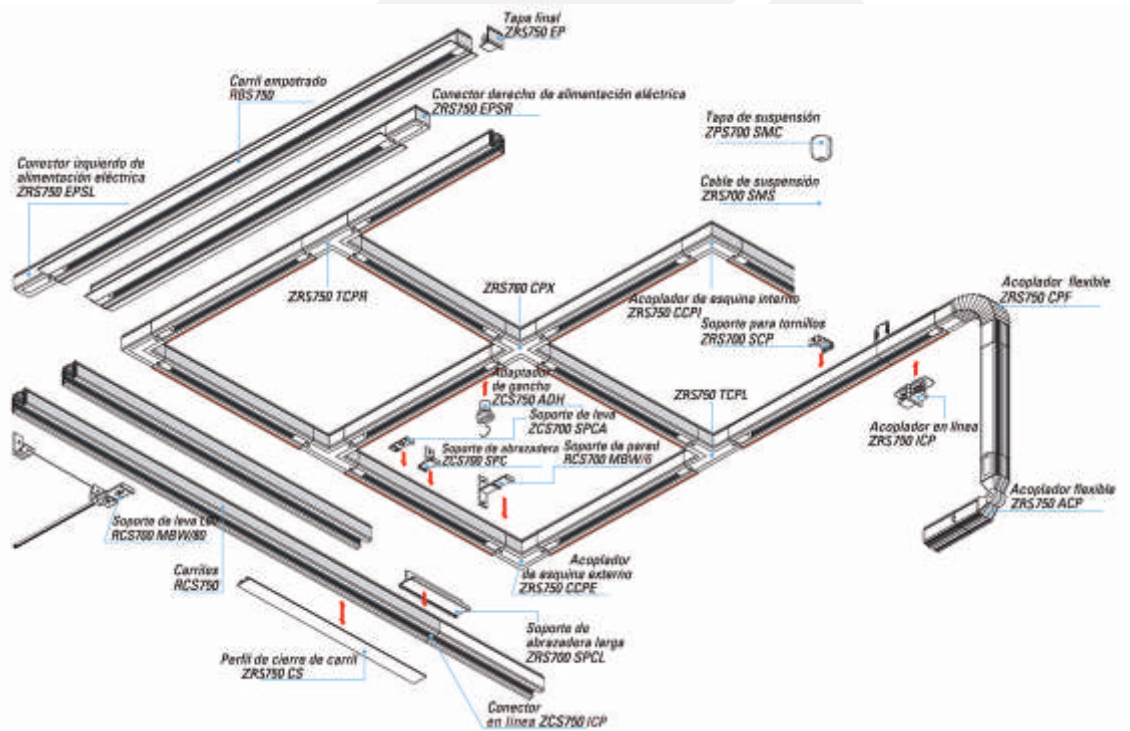



03010801

Luminarias de emergencia y accesorios



CÓDIGO	DESCRIPCIÓN	FLUJO LUZ	AUTON.	PVR	CLAVE LOGT.
--------	-------------	-----------	--------	-----	-------------

**Serie 21 IP42 IK04. Led**

0095661601	URA 21 LED NO PERMANTE	50 lm	1 h	35,22 €	1	↗
0095661602	URA 21 LED NO PERMANTE	70 lm	1 h	43,56 €	1	↗
0095661605	URA 21 LED NO PERMANTE	160 lm	1 h	50,06 €	1	↗
0095661603	URA 21 LED PERMANENTE/ NO PERMANENTE	100 lm	1 h	53,00 €	1	↗
0095661606	URA 21 LED PERMANENTE/ NO PERMANENTE	160 lm	1 h	58,44 €	1	↗
0095661607	URA 21 LED PERMANENTE/ NO PERMANENTE	350 lm	1 h	78,25 €	1	↗
0095661610	URA 21 LED PERMANENTE/ NO PERMANENTE	200 lm	2 h	104,00 €	1	↗

**Serie 34 IP42 IK04. Led**

0095661240	URA 34 LED PERMANENTE/NO PERMANENTE	70 lm	1 h	67,00 €	2	↗
0095661241	URA 34 LED PERMANENTE/NO PERMANENTE	100 lm	1 h	76,00 €	2	↗
0095661242	URA 34 LED PERMANENTE/NO PERMANENTE	150 lm	1 h	87,00 €	2	↗
0095661243	URA 34 LED PERMANENTE/NO PERMANENTE	200 lm	1 h	110,00 €	2	↗
0095661244	URA 34 LED PERMANENTE/NO PERMANENTE	350 lm	1 h	117,00 €	2	↗
0095661245	URA 34 LED PERMANENTE/NO PERMANENTE	450 lm	1 h	135,00 €	2	↗
0095661292	MARCO ANCHO DE EMPOTRAR CON BORNAS DE CONEXIÓN			16,00 €	2	↗

CÓDIGO	DESCRIPCIÓN	FLUJO LUZ	LAMP.	AUTON.	PVR	CLAVE LOGT.
--------	-------------	-----------	-------	--------	-----	-------------

**Serie B55 IP55 IK07. Fluorescencia**

0095661401	B55 no permanente con testigo de carga LED	100 lm	TL 6	1 h	50,99 €	1	↗
0095661402	B55 no permanente con testigo de carga LED	170 lm	TL 6	1 h	63,36 €	3	↗
0095661403	B55 no permanente con testigo de carga LED	300 lm	TL 6	1 h	72,63 €	1	↗
0095661404	B55 no permanente con testigo de carga LED	450 lm	PL 11	1 h	97,88 €	3	↗
0095661409	B55 no permanente con testigo de carga LED	250 lm	PL 11	2 h	117,86 €	3	↗
0095661423	B55 COMBINADA con testigo de carga LED	100 lm	2XTL6	1 h	109,29 €	3	↗
0095661424	B55 COMBINADA con testigo de carga LED	450 lm	2XTL6	1 h	126,10 €	3	↗

**Serie 21 New IP42 IK04. Fluorescencia**

0095661710	URA 21 NEW NO PERMANENTE	50 lm	TL 6	1 h	26,42 €	1	↗
0095661701	URA 21 NEW NO PERMANENTE	70 lm	TL 6	1 h	33,54 €	1	↗
0095661702	URA 21 NEW NO PERMANENTE	110 lm	TL 6	1 h	41,49 €	1	↗
0095661705	URA 21 NEW NO PERMANENTE	160 lm	TL 6	1 h	47,68 €	1	↗
0095661706	URA 21 NEW NO PERMANENTE	240 lm	TL 6	1 h	55,66 €	1	↗
0095661707	URA 21 NEW NO PERMANENTE	300 lm	TL 6	1 h	63,88 €	1	↗
0095661709	URA 21 NEW COMBINADA	160 lm	2XTL6	1 h	110,70 €	1	↗
0095661720	MARCO DE EMPOTRAR EN TECHO				10,34 €	1	↗

**Serie NFL65 IP65 IK07. Fluorescencia**

009561847	NFL 65 NO PERMANENTE	770 lm	PL 13	1 h	283,65 €	3	↗
-----------	----------------------	--------	-------	-----	----------	---	---



CÓDIGO	DESCRIPCIÓN	FLUJO LUZ	AUTON.	PVR	CLAVE LOGT.	
Dunna IP42 IK04. Led						
	004101D60L	DUNNA LED NO PERMANTENE D-60-L	10 lm	1 h	27,76 €	2
	004101D150L	DUNNA LED NO PERMANTENE D-150-L	130 lm	1 h	38,44 €	2
	004101D200L	DUNNA LED NO PERMANTENE D-200-L	230 lm	1 h	41,53 €	2
	004101D300L	DUNNA LED NO PERMANTENE D-300-L	300 lm	1 h	52,51 €	2
	004101DL60	DUNNA LED PERMANTENE DL-60	10 lm	1 h	71,60 €	2
	004101DL150	DUNNA LED PERMANTENE DL-150	130 lm	1 h	90,35 €	2
	004101DL200	DUNNA LED PERMANTENE DL-200	230 lm	1 h	109,55 €	2
	004101DL300	DUNNA LED PERMANTENE DL-300	300 lm	1 h	126,86 €	2
	004101DMEL	MARCO PARA EMPOTRAR SERIE DUNNA. COLOR BLANCO.			6,45 €	2
	004101DMS	ENVOLVENTE ESTANCO PARA SERIE DUNNA IP65 IK07			16,93 €	2

Hermetic IP65 IK 07. Led

004101DE60L	HERMETIC LED NO PERMANTENE DE-60-L	10 lm	1 h	41,06 €	2
004101DE150L	HERMETIC LED NO PERMANTENE DE-150-L	130 lm	1 h	48,88 €	2
004101DE200L	HERMETIC LED NO PERMANTENE DE-200-L	230 lm	1 h	53,56 €	2
004101DE300L	HERMETIC LED NO PERMANTENE DE-300-L	300 lm	1 h	59,73 €	3
004101DEL60	HERMETIC LED PERMANTENE DEL-60	10 lm	1 h	75,82 €	2
004101DEL150	HERMETIC LED PERMANTENE DEL-150	130 lm	1 h	111,61 €	2
004101DEL200	HERMETIC LED PERMANTENE DEL-200	230 lm	1 h	119,50 €	2
004101DEL300	HERMETIC LED PERMANTENE DEL-300	300 lm	1 h	135,73 €	3



CÓDIGO	DESCRIPCIÓN	FLUJO LUZ	AUTON.	PVR	CLAVE LOGT.	
Diana Zero IP42 IK04. Led						
	0979LDM5050C	Diana Zero Led No permanente	50 lm	1 h	27,50 €	2
	0979LDM5070C	Diana Zero Led No permanente	70 lm	1 h	30,90 €	2
	0979LDM5110C	Diana Zero Led No permanente	110 lm	1 h	35,00 €	2
	0979LDM5150C	Diana Zero Led No permanente	150 lm	1 h	40,90 €	2
	0979LDM5200C	Diana Zero Led No permanente	200 lm	1 h	44,90 €	2
	0979LDM5300C	Diana Zero Led No permanente	285 lm	1 h	55,00 €	2
	0979APE144	Caja IP-44 para garajes			7,03 €	2
	0979AMD0071	Marco para empotrar en techo. Color blanco			6,39 €	2
	0979APE0065	Kit Envolvente IP65			19,69 €	2

Xena 6 IP42 IK04. Led

0979LXM3050C	Xena 6 Led No permanente	50 lm	1 h	31,50 €	2
0979LXM3100C	Xena 6 Led No permanente	100 lm	1 h	32,90 €	2
0979LXM3150C	Xena 6 Led No permanente	150 lm	1 h	36,90 €	2
0979LXM3200C	Xena 6 Led No permanente	200 lm	1 h	42,90 €	2
0979LXM3300C	Xena 6 Led No permanente	300 lm	1 h	66,90 €	2
0979LXM3100CP	Xena 6 Led permanente	100 lm	1 h	41,50 €	3
0979LXM3150CP	Xena 6 Led permanente	150 lm	1 h	48,00 €	3
0979LXM3200CP	Xena 6 Led permanente	200 lm	1 h	52,00 €	3
0979LXM3300CP	Xena 6 Led permanente	300 lm	1 h	76,50 €	3
0979AMD0061	Marco para enrasar en techo luminaria XENA. Color blanco			5,40 €	2



03010802

Balizas (empotrar, superficie) y accesorios

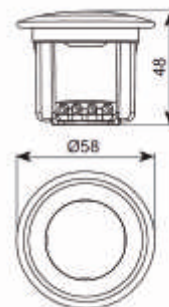
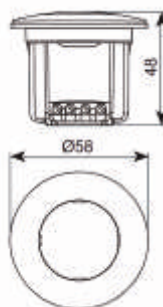

CÓDIGO	DESCRIPCIÓN	COLOR EMERG.	COLOR SENAL.	AUTO.	PVR	CLAVE LOGT.	
Piloto Lipso autónomo 230V IP44 IK07							
0095660901	PILOTO BALIZADO LIPSO -LUZ LATERAL-	Blanco	Azul	1 h	70,70 €	3	↗
0095660902	PILOTO BALIZADO LIPSO -LUZ LATERAL-	Blanco	Blanco	1 h	70,70 €	3	↗
0095660903	PILOTO BALIZADO LIPSO -LUZ LATERAL-	Blanco	Rojo	1 h	63,23 €	3	↗
0095660904	PILOTO BALIZADO LIPSO -LUZ LATERAL-	Blanco	Verde	1 h	63,23 €	3	↗
0095660905	PILOTO BALIZADO LIPSO -LUZ LATERAL-	Blanco	Ámbar	1 h	63,23 €	3	↗
0095660911	PILOTO BALIZADO LIPSO -LUZ FRONTAL-	Blanco	Azul	1 h	70,70 €	3	↗
0095660912	PILOTO BALIZADO LIPSO -LUZ FRONTAL-	Blanco	Blanco	1 h	70,70 €	3	↗
0095660913	PILOTO BALIZADO LIPSO -LUZ FRONTAL-	Blanco	Rojo	1 h	63,23 €	3	↗
0095660914	PILOTO BALIZADO LIPSO -LUZ FRONTAL-	Blanco	Verde	1 h	63,23 €	3	↗
0095660915	PILOTO BALIZADO LIPSO -LUZ FRONTAL-	Blanco	Ámbar	1 h	63,23 €	3	↗

Piloto Lipso autónomo 230V IP66 IK08

0095660906	PILOTO BALIZADO LIPSO -LUZ LATERAL-	Blanco	Blanco	1 h	75,06 €	3	↗
0095660907	PILOTO BALIZADO LIPSO -LUZ LATERAL-	Blanco	Azul	1 h	75,06 €	3	↗
0095660916	PILOTO BALIZADO LIPSO -LUZ FRONTAL-	Blanco	Blanco	1 h	75,06 €	3	↗
0095660917	PILOTO BALIZADO LIPSO -LUZ FRONTAL-	Blanco	Azul	1 h	75,06 €	3	↗

Piloto Lipso de cortesía 230 IP44 IK07

0095660952	PILOTO CORTESIA LIPSO -LUZ LATERAL-		Blanco		61,80 €	3	↗
0095660951	PILOTO CORTESIA LIPSO -LUZ LATERAL-		Azul		61,80 €	3	↗
0095660954	PILOTO CORTESIA LIPSO -LUZ LATERAL-		Blanco		60,60 €	3	↗
0095660953	PILOTO CORTESIA LIPSO -LUZ LATERAL-		Azul		60,60 €	3	↗

Piloto Lipso centralizado IP44 IK07



0095660921	PILOTO BALIZADO LIPSO -LUZ LATERAL-	Blanco	Azul	1 h	63,23 €	3	↗
0095660922	PILOTO BALIZADO LIPSO -LUZ LATERAL-	Blanco	Blanco	1 h	63,23 €	3	↗
0095660923	PILOTO BALIZADO LIPSO -LUZ LATERAL-	Blanco	Rojo	1 h	54,35 €	3	↗
0095660924	PILOTO BALIZADO LIPSO -LUZ LATERAL-	Blanco	Verde	1 h	54,35 €	3	↗
0095660925	PILOTO BALIZADO LIPSO -LUZ LATERAL-	Blanco	Ámbar	1 h	54,35 €	3	↗
0095660931	PILOTO BALIZADO LIPSO -LUZ FRONTAL-	Blanco	Azul	1 h	63,23 €	3	↗
0095660932	PILOTO BALIZADO LIPSO -LUZ FRONTAL-	Blanco	Blanco	1 h	63,23 €	3	↗
0095660933	PILOTO BALIZADO LIPSO -LUZ FRONTAL-	Blanco	Rojo	1 h	54,35 €	3	↗
0095660934	PILOTO BALIZADO LIPSO -LUZ FRONTAL-	Blanco	Verde	1 h	54,35 €	3	↗
0095660935	PILOTO BALIZADO LIPSO -LUZ FRONTAL-	Blanco	Ámbar	1 h	54,35 €	3	↗

Piloto Lipso centralizado 230V IP66 IK08

0095660926	PILOTO BALIZADO LIPSO -LUZ LATERAL-	Blanco	Blanco	1 h	69,48 €	3	↗
0095660927	PILOTO BALIZADO LIPSO -LUZ LATERAL-	Blanco	Azul	1 h	69,48 €	3	↗
0095660936	PILOTO BALIZADO LIPSO -LUZ FRONTAL-	Blanco	Blanco	1 h	69,48 €	3	↗
0095660937	PILOTO BALIZADO LIPSO -LUZ FRONTAL-	Blanco	Azul	1 h	69,48 €	3	↗

CÓDIGO	DESCRIPCIÓN	PVR	CLAVE LOGT.	
--------	-------------	-----	-------------	--

Fuentes de alimentación para equipos centralizados

009561865	Equipo PB, para alimentar un máximo de 30 pilotos	453,95 €	3	
009561866	Equipo PB, para alimentar un máximo de 85 pilotos	606,19 €	3	

Accesorios Lipso

0095660941	CAJA EMPOTRAR	2,61 €	3	
0095660942	ADAPTADOR CAJA UNIVERSAL	16,97 €	3	
0095660943	ADAPTADOR TABIQUES PREFABRICADOS	5,58 €	3	
0095660944	MARCO REDONDO 68MM.	7,83 €	3	
0095660945	MARCO CUADRADO 68MM.	7,61 €	3	
0095660946	LIPSO DIFUSOR REPUESTO	1,54 €	3	





03010803

Proyectores



CÓDIGO	DESCRIPCIÓN	FLUJO LUZ	POT.	IP	PVR	CLAVE LOGT.	
--------	-------------	-----------	------	----	-----	-------------	--

Proyectores autonomos ik07. 1 hora de autonomia. Halógenos

0095660841	PROYECTOR 2 FOCOS	365 lm	2X15w	55	427,79 €	3	
0095660842	PROYECTOR 2 FOCOS	800 lm	2X35w	55	553,13 €	3	
0095660843	PROYECTOR 2 FOCOS	1500 lm	2X65w	45	1.014,39 €	3	
0095660844	PROYECTOR 4 FOCOS	600 lm	4X15w	55	765,61 €	3	
0095660845	PROYECTOR 4 FOCOS	1100 lm	4X25w	45	1.067,02 €	3	



03010804

Accesorios



CÓDIGO	DESCRIPCIÓN	AUTON.	POT.	TIEMPO CARGA	PVR	CLAVE LOGT.	
--------	-------------	--------	------	--------------	-----	-------------	--

Kits de conversión de fluorescencia convencional a emergencia

009561840	KIT DE CONVERSIÓN	1 h	6 a 36w	1 h	126,02 €	3	
009561842	KIT DE CONVERSIÓN	1 h	6 a 58w	1 h	207,29 €	3	



Concebidos para integrarse en luminarias fluorescentes lineales, compactas y circulares (entre 6 y 58W) para transformarlas en luminarias de emergencia de tipo permanente o no permanente.



03010901

Luminarias específicas (atex, altas y bajas temperaturas)

opciones

CÓDIGO	DESCRIPCIÓN	POT.	LONGT.	REACT.	PVR	CLAVE LOGT.
--------	-------------	------	--------	--------	-----	-------------

**Serie 9. Luminaria AX Tepara Zona 1,2 (Atex II 2G) IP65**

07279218S2HF	ATEX 2G EEX ED IIC	2X18w	760 mm	electron.	297,68 €	3
07279236S4HF	ATEX 2G EEX ED IIC	2X36w	1.365 mm	electron.	304,35 €	3
07279258S5HF	ATEX 2G EEX ED IIC	2X58w	1.665 mm	electron.	346,05 €	3

CÓDIGO	DESCRIPCIÓN	POT.	LONGT.	AUTON.	PVR	CLAVE LOGT.
--------	-------------	------	--------	--------	-----	-------------

**Serie 9. Luminaria emergencia Atex para Zona 1,2 (Atex II 2G) IP65**

07279218S2HFEM	EMERGENCIA ATEX 2G EEX ED IIC	2X18w	760 mm	3 h	689,74 €	3
07279236S4HFEM	EMERGENCIA ATEX 2G EEX ED IIC	2X36w	1.365 mm	3 h	701,38 €	3
07279258S5HFEM	EMERGENCIA ATEX 2G EEX ED IIC	2X58w	1.665 mm	3 h	742,41 €	3

CARACTERÍSTICAS**Certificación:** II 2 G EEx ed IIC T4/5.**Certificado:** SIRA 00ATEX 3071.**Instalación:** Zona 1-2-22.**Grado de protección:** IP65.**Temperatura:** -20 a +55°C.**Voltaje:** 230V 50/60Hz.**Material:** Cuerpo: Aluminio resistente corrosión.

Difusor: Policarbonato resistente impactos.

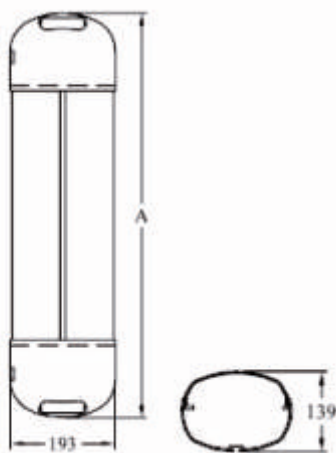
Reactancia: Electrónica.**Montaje:** 2 orificios de fijación M8.**Entradas:** 4 entradas M20 (2 taponadas).

CÓDIGO	DESCRIPCIÓN	POT.	DIMENSIONES(mm) AXBXCXD XEF	REACT.	PVR	CLAVE LOGT.
--------	-------------	------	--------------------------------	--------	-----	----------------



Serie Vipet-N-I. Luminaria Atex para Zona 2,22 (Atex II) 3GD. IP66

0727522402X18W	VIPET. ZONA 2,22	2X18w	685X173X110X230X340	Induct.	94,60 €	3
0727522412X18W	VIPET. ZONA 2,22	2X18w	685X173X110X230X340	Capacit.	95,89 €	3
072752242	VIPET. ZONA 2,22	2X18w	685X173X110X230X340	Electron.	96,49 €	3
0727524401X18W	VIPET. ZONA 2,22	1X18w	685X119X110X176X340	Induct.	72,33 €	3
0727524411X18W	VIPET. ZONA 2,22	1X18w	685X119X110X176X340	Capacit.	73,67 €	3
0727524421X18W	VIPET. ZONA 2,22	1X18w	685X119X110X176X340	Electron.	85,32 €	3
0727520802X36W	VIPET. ZONA 2,22	2X36w	1290X173X110X230X700	Induct.	111,54 €	3
0727520812X36W	VIPET. ZONA 2,22	2X36w	1290X173X110X230X700	Capacit.	112,91 €	3
072752082	VIPET. ZONA 2,22	2X36w	1290X173X110X230X700	Electron.	129,58 €	3
0727521401X36W	VIPET. ZONA 2,22	1X36w	1290X119X110X167X700	Induct.	86,30 €	3
0727521411X36W	VIPET. ZONA 2,22	1X36w	1290X119X110X167X700	Capacit.	87,65 €	3
0727521421X36W	VIPET. ZONA 2,22	1X36w	1290X119X110X167X700	Electron.	102,84 €	3
0727523402X58W	VIPET. ZONA 2,22	2X58w	1590X173X100X230X1000	Induct.	133,97 €	3
0727523412X58W	VIPET. ZONA 2,22	2X58w	1590X173X100X230X1000	Capacit.	135,75 €	3
072752342	VIPET. ZONA 2,22	2X58w	1590X173X100X230X1000	Electron.	141,76 €	3
0727524801X58W	VIPET. ZONA 2,22	1X58w	1590X119X110X176X1000	Induct.	97,55 €	3
0727524811X58W	VIPET. ZONA 2,22	1X58w	1590X119X110X176X1000	Capacit.	98,93 €	3
0727524821X58W	VIPET. ZONA 2,22	1X58w	1590X119X110X176X1000	Electron.	106,80 €	3

CARACTERÍSTICAS

Certificación: II 3 GD Ex nA tD A II T4/T5.

Certificado: FTZÚ 02 ATEX 0313X.

Instalación: Zona 2-22.

Grado de protección: IP66.

Temperatura: -20° a +40°C.

Voltaje: 230V 50Hz.

Material: Cuerpo: Policarbonato.

Difusor: Policarbonato.

Clips: Acero inox.

Reactancia: Electrónica, inductiva o capacitiva (con condensador).

Montaje: Directamente a la superficie mediante clips, o en suspensión con cable o ganchos.

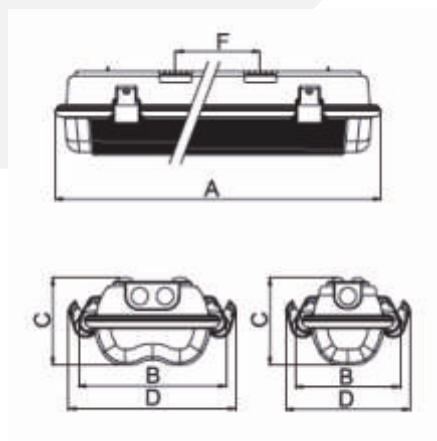



03010902

Luminarias salas limpias

PHILIPS



CÓDIGO	DESCRIPCIÓN	POT.	LONGT.	ÓPTICA	PVR	CLAVE LOGT.
--------	-------------	------	--------	--------	-----	-------------

Luminaria polivalente IP65. IK08. Fluorescencia

096989573100	CR200B. Fabricada en acero. Pintada en blanco RAL 9003	4X14w	597x597x572x572x82	Cristal termo-endurecid. 4mm	311,00 €	3	↗
096989574800	CR200B. Fabricada en acero. Pintada en blanco RAL 9003	4X24w	597x597x572x572x82	Cristal termo-endurecid. 4mm	311,00 €	3	↗
096989575500	CR200B. Fabricada en acero. Pintada en blanco RAL 9003	2X54w	297x1197x272x572x82	Cristal termo-endurecid. 4mm	334,00 €	3	↗
096989576200	CR200B. Fabricada en acero. Pintada en blanco RAL 9003	4X14w	597x597x572x572x82	Opa acrílico PMMA 3mm	245,00 €	3	↗
096989577900	CR200B. Fabricada en acero. Pintada en blanco RAL 9003	4X24w	597x597x572x572x82	Opa acrílico PMMA 3mm	245,00 €	3	↗
096989578600	CR200B. Fabricada en acero. Pintada en blanco RAL 9003	2X54w	297x1197x272x572x82	Opa acrílico PMMA 3mm	267,00 €	3	↗

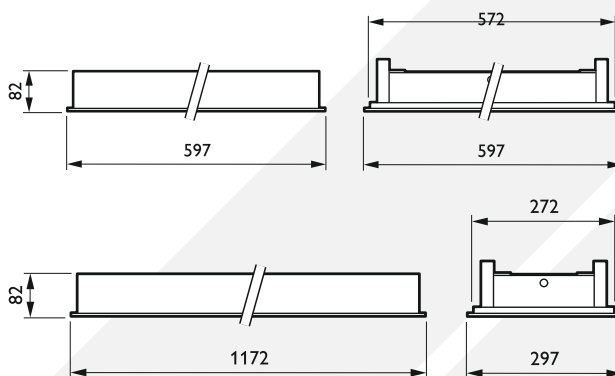

CÓDIGO	DESCRIPCIÓN	POT.	ÓPTICA	PVR	CLAVE LOGT.
--------	-------------	------	--------	-----	-------------

Space luminaria polivalente IP54. IK06. Fluorescencia

096980263000	CR991C 4x14W HFP C6	4X14w	Lama tridimensionales aluminio alto brillo	141,00 €	3	↗
096980264700	CR991C 4x14W HFP O	4X14w	Cierre opal de policarbonato	173,00 €	3	↗
096980265400	CR991C 4x14W HFP P	4X14w	Cierre prismático de PMMA	129,00 €	3	↗
096980266100	CR991C 4x14W HFP C3	4X14w	Reflector aluminio brillo y las planas aluminio mate	198,00 €	3	↗

CÓDIGO	DESCRIPCIÓN	PVR	CLAVE LOGT.
--------	-------------	-----	-------------

Accesorios (pedir anclajes por separado)

096980267800	CR991Z muelles techo perfelería vista	24,00 €	3	↗
096980268500	CR991Z muelles techo estandar	12,00 €	3	↗

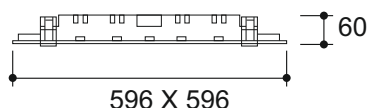

03010903

Linternas



CÓDIGO	DESCRIPCIÓN	AUTON.	LAMPARA	PVR	CLAVE LOGT.
--------	-------------	--------	---------	-----	-------------

LINTERNA RECARGABLE. HALOGENA

009561860	LINTERNA LR 206NI-CD ALTA TEMPERATURA Alumbrado intenso de luz blanca en un foco.B18	4 h 30'	2,4V/1, 25A	218,47 €	3	
-----------	---	---------	----------------	----------	---	---

CÓDIGO	DESCRIPCIÓN	PVR	CLAVE LOGT.
--------	-------------	-----	-------------

ACCESORIOS

009561861	CARGADOR 206 C. Garantiza la carga en 24h.	73,09 €	3	
-----------	--	---------	---	---

